

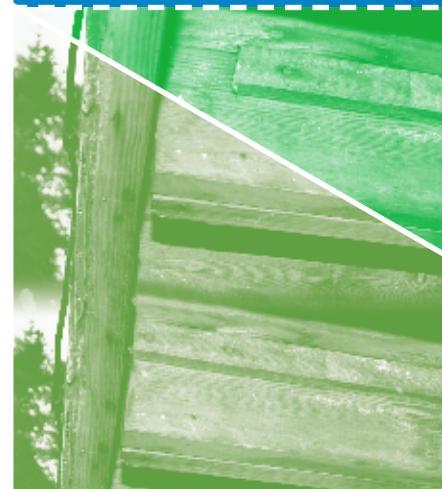

# REBUILD HEALTHY HOMES



*Guide to Post-disaster Restoration for a Safe and Healthy Home*  
[www.hud.gov/healthyhomes](http://www.hud.gov/healthyhomes)



U.S. Department of Housing and Urban Development  
Office of Lead Hazard Control and Healthy Homes  
[www.HUD.gov/healthyhomes](http://www.HUD.gov/healthyhomes)



HEALTHYHOMES

# Top 10 Tips

## for Rebuilding Healthy Homes

- 1 Remind yourself often to **put people before property!** Make safety your top priority ([page 10](#)).
- 2 **Wear personal protective equipment (PPE)**, including protective clothing and a NIOSH-approved respirator, **every** time you set foot in a damaged or moldy building ([pages 11 to 14](#)).
- 3 **Assess** structural stability and hidden hazards before you enter. A professional inspection may be needed ([pages 15 to 30](#)).
- 4 **Prepare a plan** (supplies and methods), **make a map** (disposal and clean-up site layout), and **review** insurance policies and disaster assistance resources ([pages 3](#) and [30 to 33](#)).
- 5 **Go slow** when pumping out water, then **act fast** to dry out and remove mold. Copy and share the *DIY Mold Removal Guidelines* sheet with workers ([pages 41](#) and [50 to 53](#)).
- 6 **Always remove wet insulation and foam padding**, even if the surface looks dry and clean ([pages 48 and 49](#)).
- 7 **Assume lead-based paint and asbestos** are in homes built before 1978 (unless verified not present). Be mindful that disturbing such materials increases the hazard ([pages 24 to 28](#)).
- 8 **Control dust, capture debris and contain contaminants** – with wet methods, drop cloths, debris bags, HEPA vacuums and workers trained in safe work practices ([pages 25 to 28, 39 and 40](#)).
- 9 **Check credentials** and hire only licensed and insured contractors, Lead-Safe Certified Renovators, certified Asbestos professionals, Mold Remediation Contractors, Fire and Water Damage Restorers, and other professionals, depending on types of work needed ([pages 33 to 35](#)).
- 10 **Restore for *More* than Before!** Install hazard-resistant materials, connectors and building systems. Include energy-saving and **healthy home improvements** ([pages 53 to 64](#)).

See [Appendix](#) for more sources of helpful information.



# REBUILD HEALTHY HOMES

*Guide to Post-disaster Restoration for a Safe and Healthy Home*  
[www.hud.gov/healthyhomes](http://www.hud.gov/healthyhomes)

When disaster strikes, you're eager to restore your home and life quickly. So many things depend on being able to resume living in your home. Unfortunately, that eagerness often ends up putting property before people in the haste to get the work done as soon as possible.

This guide was developed **to help homeowners, volunteers and other workers to restore damaged homes in a way that puts people first.** It includes how-to methods, tips and improvement ideas for safe restoration that result in not just a livable dwelling, but **a healthy home that offers even *more* than before.**



U.S. Department of Housing and Urban Development  
Office of Lead Hazard Control and Healthy Homes

MAY 2015



## Acknowledgments

This guide is published and provided by the  
**U.S. Department of Housing and Urban Development**  
**Office of Lead Hazard Control and Healthy Homes**  
to help households and volunteers restore safe and healthy homes after a natural disaster.

### Prepared by

**Atrium Environmental Health and Safety Services, LLC, Reston, VA**

### Primary author

**Claudette Hanks Reichel, Ed.D.**

Professor and Extension Housing Specialist

Director, LaHouse Resource Center

Louisiana State University Agricultural Center (LSU AgCenter) – Louisiana Cooperative Extension Service

**This guide was enriched by the contributions and reviews of the following experts  
whose input is much appreciated:**

### Content contributors

**Kathleen Autilio**, Graduate Assistant, LSU AgCenter – LaHouse Resource Center

**Michael Goldschmidt**, LEED AP BD+C, Extension Housing and Environmental Design Specialist, University of Missouri

This guide expands upon and replaces the 2006 edition of *Rebuild Healthy Homes: Safe Rehabilitation of Hurricane-Damaged Homes Student Guide*. Prepared by **Consolidated Safety Services (Fairfax, VA)**

### Reviewers

**Katherine Allen**, County Director, University of Florida Extension Service

**Daniel O. Chute**, CIH, CSP, Atrium Environmental Health and Safety Services

**Warren Friedman**, Ph.D., CIH, FAIHA, U.S. Department of Housing and Urban Development Office of Lead Hazard Control and Healthy Homes

**Abby Hugill**, U.S. Department of Housing and Urban Development Office of Lead Hazard Control and Healthy Homes

**Carly Johnson**, Atrium Environmental Health and Safety Services

**Sarah Kirby**, Associate Professor and Extension Housing Specialist, North Carolina State University Extension Service

**Paul LaGrange**, Extension Building Science Educator, LSU AgCenter and LaGrange Consulting

**Glenn Ray**, Extension Building Science Educator, LSU AgCenter and RTC of Louisiana, LLC

**William Robinson**, Extension Building Science Educator, LSU AgCenter and Train to Build, Inc.

**Clyde Kitt Rodkey**, U.S. Department of Housing and Urban Development Office of Lead Hazard Control and Healthy Homes

### Participants of focus groups

New Orleans, LA; Columbia, MO; and Reston, VA

**Focus groups were facilitated by:**

**New Orleans, LA:** Claudette Reichel, moderator; Jensen Killen and Lee Rouse

**Columbia, MO:** Michael Goldschmidt, moderator; Michael Lam and James Hopfenblatt

**Reston, VA:** Daniel Chute, moderator; Anna Varone (Reston Association), Carly Johnson

### Design and illustrations

**Sagetopia & John Rodgers**

**Mark Lindamood**, Editor

### Disclaimer

Mention of non-federal agencies or their websites does not imply HUD or federal government endorsement or approval of the organizations or their websites' contents, nor of individuals, firms, or procedures or practices mentioned by or linked from the websites.

## Table of Contents

<b>Top 10 Tips for Rebuilding Healthy Homes</b>	II
<b>Acknowledgments</b>	IV
<b>Fair Housing Laws and Restoration</b>	VI
<b>Guiding Goals</b>	1
<b>Disaster Damages</b>	3
<b>Types of Natural Hazards and Typical Damages to Homes</b>	4
Floods	4
Hurricanes	5
Tornadoes	5
Hail	6
Earthquakes	6
Wildfires	7
Winter Storms/Freezes	7
Extreme Heat/Droughts	8
Tsunamis/Storm Surges/Levee Failures	8
Mudslides/Sinkholes/Debris Slides	8
<b>How-to Restoration Guide for a Healthy Home</b>	9
<b>Protect Yourself... First and Foremost</b>	10
Personal Protective Equipment (PPE)	11
Accident Prevention	14
<b>Assess Damages and Hazards</b>	15
Assess Structural Stability	15
Inspect for Creatures, Chemicals and Bio-Hazards	17
Inspect Utilities—Electrical, Gas and Water Supply	18
Inspect Heating, Ventilation, and Air-Conditioning (HVAC) System	20
Assess Health Hazards	21
• Mold	21
• Lead in Paint, Dust and Soil	24
• Asbestos	26
• Radon	28
<b>Create a Work Plan</b>	30
• Supplies and Materials	30
• Electricity	30
• Storage Areas	31
• Disposal	31
• Site Layout	31
• Selecting Qualified Contractors	33
<b>Prepare the Work Site</b>	35
Install Temporary Weather Barriers	35
Provide Basics	36
Take Precautions	36
Set Up a Clean-up Station	37
Set Up Containment	39
<b>Clean-Out and Tear-Out</b>	39
Removing Contents	41
• Furniture	42
• Appliances and Fixtures	42
• Carpeting and Rugs	43
• Small Objects	44
Gutting and Tear-Out (Demolition)	44
• Cabinets, Shelves, Doors, and Trims	45
• Ceilings	46
• Walls	46
• Floors	48
• Insulation	48
• Exterior Claddings	49
<b>Clean and Decontaminate</b>	50
Mold	50
Surface Cleaning and Treatment	50
<b>Restore for More than Before</b>	53
Resilient Home Improvements	54
• Borate treatment of structural wood	54
• Flood-resistant features	54
• Wind- and hail-resistant improvements	56
• Earthquake resistant improvements	58
• Wildfire protections	59
• Freeze/snow-tolerant upgrades	59
• Heat/drought management strategies	60
• Tsunamis/storm surge rebuilding	60
• Sinkholes/mudslides/falling debris and any catastrophe	60

Healthy Home Improvements . . . . . 61

- Keep it Dry . . . . . 61
- Keep it Clean . . . . . 61
- Keep it Pest Free . . . . . 61
- Keep it Safe . . . . . 62
- Keep it Contaminant-Free . . . . . 62
- Keep it Properly Ventilated . . . . . 63
- Keep It Maintained . . . . . 64
- Keep it Comfortable . . . . . 64

**List of Sidebars**

Disaster Assistance Resources . . . . . 3

Dealing with Stress and Grief . . . . . 4

Hurricane Damages by Strength Category . . . . . 5

Tornado Damages by Rating . . . . . 6

Snow Load . . . . . 8

If you rent your home.... . . . . 9

Home Restoration Steps . . . . . 10

Respirator Cautions . . . . . 12

Collapse Warning Signs . . . . . 15

Mold Myths . . . . . 23

Flooding and Mold Growth . . . . . 23

Heat/Cold Precautions . . . . . 37

Clean, Gray and Black Water . . . . . 43

Shingle Wind Ratings . . . . . 57

**List of Illustrations**

Illustration A – Personal Protective Equipment (PPE) . . . . . 13

Illustration B – Structural Flaws . . . . . 16

Illustration C – Shutting Off Utilities . . . . . 19

Illustration D – Sample Site Layout . . . . . 32

Illustration E – Clean-up, Health and Safety Station . . . . . 38

Illustration F – Creating a Containment Area Plastic Sheet Flap Seal . . . . . 40

**Appendices**

Appendix 1 – Supplies and Materials . . . . . 65

Appendix 2 – Glossary . . . . . 67

Appendix 3 – For More Information... . . . . 71

## Fair Housing Laws and Restoration

HUD enforces the Fair Housing Act and other federal laws that prohibit housing discrimination and the intimidation of people in their homes, apartment buildings, and condominium developments. Nearly all housing transactions are protected, including rental and sale of housing and the provision of mortgage loans.

When a natural disaster strikes, emergency professionals and the general public need to know that they are entitled to equal access to housing opportunities and that the federal Fair Housing Act provides protection against unfair housing practices. Landlords who refuse to rent or sell homes to people on the basis of race, color, national origin, religion, sex, familial status, or disability are violating federal law.

Since catastrophic events can happen at any time and any place, housing professionals have a responsibility to prepare communities and to ensure that equal housing opportunities are afforded to all.

# Guiding Goals For a Healthy Home

**T**he link between health and housing is proven. Even a clean and beautiful home can have health hazards ranging from allergy and asthma triggers to disease-causing or deadly pollutants.

A damaged home is likely to pose serious health risks, such as **unsafe conditions, mold, asbestos, lead-based paint, polluted water, sewage and other contaminants.**

The wrong restoration methods can worsen, or even cause, some hazards.

Everyone wants to live in a healthy home. With good information and a commitment to doing it right, you can safely repair and rebuild a *healthy* home after a natural disaster. To achieve that, you need to know, plan for, and apply the eight **principles of healthy housing**:

**1. Be SAFE – Protect yourself and others from injury during and after restoration.**

Injuries *after* the disaster is over – from chainsaw accidents, cuts, electrical shock, sprains and strains, falls, burns and other accidents – are all too common. Damaged buildings are dangerous. People are stressed and tired. Materials are in short supply. Clean-up and repair work is time consuming. You can overcome those challenges and avoid injuries with the preparations and tips in this guide.

**2. Get it DRY – Dry out or remove wet materials as quickly as possible.**

Dampness supports mold, bacteria, and pests, creating an unhealthy living space. A wet home needs special attention to avoid or correct a major mold problem. That’s why it’s so important to properly dry the home out as soon as possible and keep it dry.

**3. Get it CLEAN – Remove debris, silt and grime with safe and effective cleaning methods.**

It’s obvious that damage and debris must be cleaned out, but *how to do it most effectively and safely* is not so obvious. Damaged buildings can have hidden dangers and lingering health hazards. Special methods are needed to restore a truly clean and healthy home.

**4. Get it PEST-FREE – Exclude pests, using little or no toxic pesticides.**

A damaged home can be vulnerable to invasion by unwelcome pests. You know that pests can spread disease, but did you know that insect and rodent droppings are a major trigger of allergies and asthma? Invading animals can also bring in ticks and fleas. Termites can damage your home.

**CAUTION!** Solving one health hazard (pests) with another (toxic pesticides) isn't your only option. **Integrated pest management (IPM)** uses knowledge about pest behavior and methods to control pests with the least possible hazard to people, property, and the environment. Home restoration is a prime opportunity to apply key IPM methods for keeping pests out of your home.

**5. Get it CONTAMINANT-FREE – Correctly remove and control the spread of indoor pollutants.**

Property damage can expose hidden health hazards. Making matters worse, the repair process itself can release and greatly increase your exposure to indoor pollutants, such as: lead, asbestos, mold, sewage, other bio-hazards, toxic chemicals and fumes, dust, fiberglass, carbon monoxide, smoke, soot and radon, among others. Using this guide can help you reduce exposure to these pollutants.

**6. Keep it PROPERLY VENTILATED – Exhaust bad air, bring in good air, control humidity.**

Every home needs some fresh air ventilation to dilute indoor air pollutants that off-gas from products and people. Damaged heating and cooling equipment, debris, the clean-out process, and repair work can multiply the indoor air pollution load many times over. The consequence can even be deadly – but not if you know what to do.

**7. Make it easy to MAINTAIN – Restore for a more durable, easy-care home.**

A well-maintained home prevents water leaks, decay, pest invasions – and reduces the expense and hassle of repairs. When Mother Nature damages your home, its restoration may create an opportunity to use better materials and methods that make your home more durable and easier to maintain.

**8. Make it COMFORTABLE – Control your indoor climate.**

When restoring your damaged home, include heating, cooling and other energy-efficiency improvements that make it affordable to stay warm in winter and cool in summer – even during power outages.

# Disaster Damages



**B**efore you return home or begin the restoration process, find the natural hazard below that applies to you. Review the types of damage that are common to that event to help you anticipate and better prepare. Some repairs may be beyond what you can tackle without professional services. Take time to plan for and gather supplies that may be hard to find in the disaster area. Explore resources and local organizations that may be available to help.

... DISASTER ASSISTANCE RESOURCES ...

**Homeowner's insurance and flood insurance** are the primary financial resources for most homeowners. Review your policies and their limits before you begin recovery efforts. Contact your insurance company promptly to report your damages. Take photos of all damages to show the claims agent, but do not wait for the agent to visit your home before beginning clean-up and repairs.

Note that homeowner's insurance does not cover flood damage, may have a higher deductible for wind damage than other perils, and may exclude mold or other types of damage. Flood insurance is made available by and claims are paid by the National Flood Insurance Program (learn more at [www.FloodSmart.gov](http://www.FloodSmart.gov)). Typically, there's a 30-day waiting period from date of purchase before a flood policy goes into effect. That's why it's so important for a flood insurance policy to be obtained long before a hazard warning, and that it be maintained.

Following a *Presidential Disaster Declaration*, the **Federal Emergency Management Agency (FEMA)** helps state and local governments with recovery operations. Funding and other types of assistance are made available to residents whose property has been damaged and whose losses are not covered by insurance. Declared counties and disaster assistance information are available on the FEMA website at [www.fema.gov](http://www.fema.gov) and [www.DisasterAssistance.gov](http://www.DisasterAssistance.gov). Temporary **Disaster Recovery Centers** may be set up to assist applicants in person with information about FEMA or other disaster assistance programs and questions.

Some faith-based and **charitable organizations** provide financial assistance. Such assistance does not require a Presidential declaration of disaster, so it may be available in counties that were not declared. **Contact the emergency management office in your county or state to find out what assistance is being offered.**

**Keep in mind** that finding damage to your home may be emotionally traumatic. Prepare yourself for the possibilities. Use these tips for dealing with stress and the grief you may experience. Locate service providers who are qualified and available to help.

... DEALING WITH STRESS AND GRIEF ...

- ▶ **Prepare yourself** for the possibility that seeing your damaged home in person may hit you harder than seeing pictures or news reports before you return home.
  - ▶ **Limit your exposure** to traumatic news coverage and social media about the disaster until you can handle it without a toll on your well-being.
  - ▶ **Refocus your attention** on positive things, and what you *can* do. Make a list and plan of action.
  - ▶ **Stay connected** with family and friends. Try to resume as many personal routines as possible. Try to do something with others that you and they have enjoyed in the past.
  - ▶ **Don't skip meals.** Drink plenty of water and eat healthy meals. Avoid alcohol and other depressants. Stay on schedule with any doctor-prescribed medications and procedures.
  - ▶ **Limit the time** you spend working on-site each day and week. Take breaks off-site to de-stress. Get plenty of rest.
  - ▶ **Know** that recovery will take time. Expect hurdles.
  - ▶ **Help others, and accept help** for yourself.
  - ▶ **Watch for signs of depression** or despair in yourself and others. If they persist beyond the expected effects of fatigue, seek help from your doctor, a counselor or other mental health professional. According to the National Institute of Mental Health ([www.nimh.nih.gov](http://www.nimh.nih.gov)), symptoms of depression may include the following:
    1. Difficulty concentrating, remembering details, and making decisions
    2. Fatigue and decreased energy
    3. Feelings of guilt, worthlessness, and/or helplessness
    4. Feelings of hopelessness and/or pessimism
    5. Insomnia, early-morning wakefulness, or excessive sleeping
    6. Irritability, restlessness
    7. Loss of interest in activities once enjoyed
    8. Overeating or appetite loss
    9. Persistent aches or pains, or digestive problems that do not ease when treated
    10. Persistent sad, anxious, or "empty" feelings
    11. Thoughts of suicide, suicide attempts
- ▶ If you (or someone you know) is thinking of suicide or self-harm, call the toll-free, 24-hour hotline of the National Suicide Prevention Lifeline at 1-800-273-TALK (1-800-273-8255) to be connected to a trained counselor at a suicide crisis center nearest you.
- Note: People with hearing or speech disabilities may reach this number through the Federal Relay Service teletype service at 800-877-8339.

## Types of Natural Hazards and Typical Damages to Homes



### FLOODS

Floods are the most common natural disaster, affecting more homes than any other type of disaster. Floods can cause many kinds of damage, including those below.

- ▶ Mold is the most prominent damage following a flood, and worsens over time. Mold is a hazard to both people and property. It grows on almost any material that stays wet more than about two days. The longer mold and wetness remain, the faster it spreads.
- ▶ Rising floodwater is usually contaminated with sewage (containing disease-causing bacteria), chemicals and debris. Floods deposit these contaminants, and they may be absorbed into porous materials.



### HURRICANES

Hurricane season is from June 1 until November 30. Hurricanes are strong tropical cyclones that can produce extreme rainfall, storm surges, sustained high winds, and may include tornadoes. Damage may be widespread across hundreds of miles, affect thousands of buildings, and cause material and labor shortages. Common types of damage include:

- ▶ Roof damage (most common) – damage to or loss of shingles, underlayment, roof decking, chimneys and turbine vents. Gable-end wall failures can cause roof collapse if not braced adequately.
- ▶ Water damage from wind-driven rain – roof leaks and loss of flimsy soffits resulting in ceiling damage or collapse; leaks in walls that wet insulation; window and door leaks.
- ▶ Collapse or loss of add-on structures (screen rooms, patios, etc.).
- ▶ Damage to or pop-out of windows and doors, especially sliding glass doors.
- ▶ Structural damage (leaning, collapse) as a result of insufficient connections in framing; loss of a garage door or broken windows from flying debris.



### TORNADOES

Tornadoes occur with little or no warning. Since wind speeds can reach up to 300 mph, the focus of warnings is providing life safety via an exceptionally strong shelter that meets the Federal Emergency Management Agency (FEMA) standard for a tornado *safe room*. Damage can occur a mile wide and up to 50 miles long. Damage is greatest at the core of the funnel and less severe toward the edges of the path.

- ▶ Core path damage includes drastic uprooting or destruction of homes or parts of homes (especially porches, patios and decks).
- ▶ Flying debris and glass shards act as airborne missiles that puncture holes in buildings or break windows. Such holes can lead to amplified air pressure loads and structural failures.

### HURRICANE DAMAGES BY STRENGTH CATEGORY

- ▶ **Category 1 (74-95 mph) = Minimal Damage:** Damage is primarily to trees, unanchored mobile homes; no major damage to most structures.
- ▶ **Category 2 (96-110 mph) = Moderate Damage:** Some trees are toppled; some roof coverings are damaged; major damage to older mobile homes.
- ▶ **Category 3 (111-129 mph) = Extensive Damage:** Large trees are toppled; structural damage to roofs and small homes; mobile homes are destroyed.
- ▶ **Category 4 (130-156 mph) = Extreme Damage:** Extensive damage is done to roofs, windows, and doors; roof systems on small buildings completely fail.
- ▶ **Category 5 (157 mph +) = Catastrophic Damage:** Roof damage is considerable and widespread; window and door damage is severe; extensive glass failures; some complete buildings fail.

• • • TORNADO DAMAGES BY RATING • • •

Tornadoes are measured using the Enhanced Fujita Tornado Scale, or the EF-scale. This scale rates tornadoes from 0 to 5, based on the wind estimates and damage across 28 types of tornado indicators.

**EF 0 = Light Damage:** Chimneys are damaged; tree branches break; shallow-rooted trees are toppled.

**EF 1 = Moderate Damage:** Roof coverings are peeled off; windows are broken; some tree trunks are snapped; unanchored mobile homes are overturned; some attached garages are destroyed.

**EF 2 = Considerable Damage:** Roof structures are damaged; mobile homes are destroyed; debris becomes airborne (missiles are generated); large trees are snapped or uprooted.

**EF 3 = Severe Damage:** Roofs and some walls are torn from structures; some small buildings are destroyed; non-reinforced masonry buildings are destroyed.

**EF 4 = Devastating Damage:** Well-constructed houses are destroyed; some structures are lifted from foundations and blown some distance; large debris becomes airborne.

**EF 5 = Incredible Damage:** Strong frame houses are lifted from foundations; reinforced concrete structures are damaged; car-sized missiles become airborne.

- ▶ Homes along the outer fringes of tornadoes tend to have the same types of damage as is typical from hurricanes, with damage mostly to roofs, glass and siding.
- ▶ Even homes built to a high wind standard suffer severe damages from a direct hit strong tornado (see table above). However, they tend to withstand weaker tornadoes and the winds in the outer fringe of a strong tornado's path.
- ▶ A study by the Centers for Disease Control and Prevention (CDC) showed that 50% of tornado-related injuries occurred during rescue attempts, clean-ups and other post-storm activities. The most common injuries were from stepping on nails or broken glass.



**HAIL**

Hail is essentially a frozen raindrop, building up mass as it circulates through clouds. Hail can grow to several inches thick. As it becomes heavy it falls, sometimes reaching 90 mph. Hail can break glass, dent siding and damage or destroy roofing materials. Large hail can penetrate a roof covering and hit the underlying wood decking.



**EARTHQUAKES**

Sudden and violent ground movement leaves major structural damages. It can also result in landslides, floods, fires and tsunamis. The primary housing vulnerabilities in earthquakes include:

- ▶ Dislodged water heaters, broken water lines and flooding
- ▶ Fires, gas leaks
- ▶ Inadequately anchored homes shift off the foundation; walls, floors and roof pull apart or separate
- ▶ Weak crawl space and basement walls collapse or crack when not braced to resist movement
- ▶ Pier and post foundations fail when not reinforced against swaying



**WILDFIRES**

Houses are susceptible to wildfires by exposure to burning embers, direct flame contact, intense radiant heat, or firebrands (burning materials lifted by air currents). Damage depends on the fire intensity, its duration and the type of materials. Damages range from destruction by fire, to smoke, ash and soot deposits and/or charring of materials. Firefighting efforts can result in water damage.

Smoke, soot and ash are serious health hazards. Ash can act as a skin irritant. Soot particles can float in the air and are an irritant to the respiratory system. Oily soot can contain toxins. As the heat of a fire increases, soot becomes pressurized and forced into small cracks, crevices and into surface finishes. Smoke, soot and ash stain materials and can become trapped in window tracks, gutters, insulation, air conditioner equipment, vents, ducts and exterior drains.

Combustible roof coverings, including wood and organic asphalt shingles, are the greatest risk factor on a house. Roof design and maintenance are also crucial factors. Complicated roofs tend to accumulate flammable vegetation such as pine needles.

The main contributing factors to house wildfire risk include:

- ▶ Flammability of roof materials and collection of debris (fuel) on roofs
- ▶ Pathways (vents and gaps) allowing embers to enter the house
- ▶ Fuel sources within 5 to 10 feet of the house, including plants and landscape material
- ▶ Wood structures connected to house, such as decks and fencing
- ▶ Continuous tree canopy
- ▶ Limited access to property by firefighters.

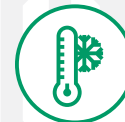

**WINTER STORMS/FREEZES**

A severe winter storm can cause extensive damage from heavy snow and ice, winds and freezing rain. Some winter storms also cause flooding. Common damages include:

- ▶ Freezing pipes that burst are the number one cause of property damage in winter storms.
- ▶ Roof ice dams are common – an accumulation of ice at the edge of a roof that prevents melting snow from draining properly off of the roof. This trapped water leaks through roofing and can damage insulation, walls and ceilings.
- ▶ Roof damage due to heavy snow build-up is common. Most buildings are designed to withstand the expected snow load of the region. When snow on a roof weighs more than 20 to 25 pounds per square foot, failures can occur.

- ▶ Gutters tend to sag or break away due to heavy snow and ice, leading to water leaking into the house. Leakage increases when debris in gutters creates blockages for snow and ice.



### EXTREME HEAT/DROUGHTS

Drought can cause soil shrinkage, resulting in uneven settling and foundation cracks. This can lead to structural damage of walls, floors and roofs. It can also cause separation from porches, garages and decks. In some areas, drought can cause sinkholes. Extreme heat poses a serious health threat to vulnerable residents, especially from dehydration.



### TSUNAMIS/STORM SURGES/LEVEE FAILURES

Tsunamis and storm surges are different coastal flood events, but they produce similar damages. A tsunami (high sea wave caused by earthquake or other underwater disturbance) takes place over a short time and produces quickly changing water levels and rushing currents. A storm surge (rising water due to a weather system) takes place over several hours with a repeated hammering of waves and winds. Levee breaks can result in a dangerous rush of water that can damage or destroy homes, depending on the type of failure and location.

- ▶ Structural damage comes from five main occurrences: force of the water, impact by water-borne debris, fires distributed by debris and liquid fuels, scour (rapid erosion of soil) resulting in foundation failure, and wind forces from wave motion.
- ▶ Collapsed walls, broken windows and doors, and even total destruction commonly occur, depending on construction methods and distance from shore. Flood damages also occur, such as debris, sediments and water damage to materials and equipment.
- ▶ Water-borne debris impact is a major problem because rushing water carries debris very quickly and rams it into buildings. In addition, debris gathers against buildings supports, creating dams that produce even higher damaging forces on the structures.



### MUDSLIDES/SINKHOLES/DEBRIS SLIDES

Mudslides, debris slides and sinkholes usually happen after a long period of rain or an intense storm. They may coincide with floods. Home damages range from modest damage to foundations, roofs and chimneys to complete destruction.

### ... SNOW LOAD

The weight of 10 to 12 inches of fresh snow is equal to 3 to 5 inches of packed/old snow which is equal to 1 inch of ice.

#### Danger zone

- ▶ 4+ feet of fresh snow
- ▶ 2+ feet of packed/old snow and
- ▶ 4+ inches of ice.

# How-to Restoration Guide for a Healthy Home



**R**eview and refer to this how-to guide throughout your home restoration process. It addresses key questions for each step in the process, including what to look for, what to do, and when work should be handled by a professional. Although this guide is focused on information that do-it-yourselfers need to know, it also provides useful criteria for contractors and other professionals.

### ... IF YOU RENT YOUR HOME... ...

The building owner or landlord is typically responsible for structural repairs and most restoration work. (Check your lease or rental agreement for specifics.) Even so, this guide can help you to safely recover many of your home's contents and restore a healthy living space. See the following sections for useful information:

- ▶ **Protect yourself first and foremost.** Wear personal protection equipment and clothing before you enter a damaged building.
- ▶ **Assess the damages and hazards** before you enter the building or your apartment.
- ▶ **Create a work plan** of what you can do, and get supplies.
- ▶ **Clean out safely** – your furniture, rugs and other possessions. Check with your landlord about how to dispose of your waste.
- ▶ **Clean-up and decontaminate.** Before you move back in, make sure your living space is properly cleaned and decontaminated to ensure a safe and healthy living space. If clean-up will be handled by the landlord, review this section to help you inspect your unit.



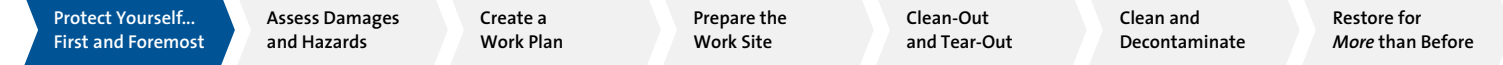
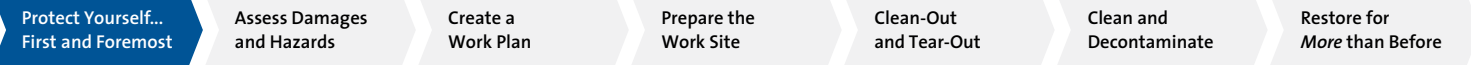

... HOME RESTORATION STEPS ...

Your work sequence should progress in the following phases. This guide includes a section about each of these steps with more information and resources to help you restore your home and protect your health.

1. **Protect yourself first and foremost.** Get and use personal protective equipment (PPE) and clothing.
2. **Assess the damages and hazards** before you begin – including structural stability, safety risks and hidden health threats. Specialists may be needed to conduct inspections and make the home safe to enter and restore.
3. **Create a work plan.** Plan tasks, supplies, professional services, disposal methods, site layout, and power sources. Get supplies and tools in advance. They may be easier to find outside the disaster area.
4. **Prepare the work site** and supplies for safe and productive work and disposal of debris.
  - When safe and feasible, get power, water and gas systems into operation.
  - Set up a health and safety station, debris layout, and work areas.
  - Cover damaged roofs, broken windows, and damaged exteriors with temporary protection.
5. **Clean-out and tear-out** using safe work practices that avoid releasing and spreading health hazards. (Training or qualified professionals are important for lead, asbestos and mold hazards).
  - If flooded, pump out water in stages (very slowly in basements).
  - Remove damaged contents. Shovel out mud and silt before it dries.
  - Remove damaged, non-restorable building materials.
6. **Clean and decontaminate** with effective methods that protect people and property.
7. **Restore ... and improve** your home.
  - Restore ONLY after steps 1 to 6 are thoroughly achieved. Restoration before materials are fully dry or safe can result in long-term problems and hazards.
  - Include home improvements that reward you with a safer, more durable and healthy home.

## Protect Yourself ... First and Foremost

Hazards (*and outcomes*) you're most likely to encounter that make personal protection so important are:

- ▶ Sharp jagged debris (*cuts and scrapes*)
- ▶ Electrical hazards (*shocks and burns*)
- ▶ Slick and unstable surfaces (*fall injuries*)
- ▶ Exposure to floodwater, chemicals, lead dust and/or asbestos (*poisoning, skin or lung damage*)
- ▶ Splashes, particles and debris in the air (*eye damage or blindness*)
- ▶ Exposure to allergens and other air pollutants (*asthma, allergic reactions, respiratory problems*)
- ▶ Contact with infectious pathogens from sewage and other sources (*illness and disease*).

## PERSONAL PROTECTIVE EQUIPMENT (PPE)

### What should I wear to protect myself?

Wear protective clothing and gear **every time** you set foot on seriously damaged property. Choose **personal protective equipment (PPE)** to protect each part of the body that could be exposed to a hazard of the task or conditions. It's best to get training in proper fitting and use of protective gear; if it doesn't fit right, it doesn't protect you.

**Lungs (internal exposure):** For most clean-up work, a NIOSH-approved rubber half-face respirator with a High Efficiency Particulate Air (HEPA) filter rated **N100 or P100** is recommended. They are available from industrial and safety equipment suppliers, some home improvement stores, and online vendors.

Do not enter moldy, dusty or potentially contaminated areas without at least a mask respirator labeled N95 or higher, worn properly. Note that N95 mask respirators do not protect against asbestos and chemical vapors. P100 respirators are needed for chemical hazards. N100 or P100 are needed for asbestos hazards, and are recommended to minimize exposure to lead paint dust.

A dust mask is NOT the same as a respirator, and does not protect you from mold spores, lead dust or fine particles (such as asbestos fibers). N100, P100 and N95 masks are readily available in home improvement stores and online. Those with a valve are more comfortable to use over long periods.

**Eyes:** Wear goggles or safety glasses with side shields, or a full-face shield.

**Ears:** Wear earplugs or earmuffs in high noise work areas.

### Most Important Tip of All:

Remind yourself often to take care of yourself and your family's health and safety first, and throughout the process of restoring a damaged home. Don't hesitate to seek medical attention for any signs of illness, infection or injury after a disaster and during clean-up.



PHOTO: NIOSH-approved P100 half-face respirator for asbestos and chemical hazards.



PHOTO: N95 mask respirator with comfort valve.

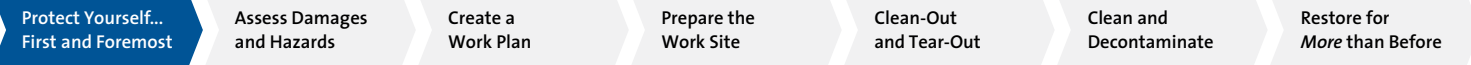

... RESPIRATOR CAUTIONS ...

If you buy a respirator or use a borrowed one, thoroughly read the instructions. It should be fit-tested to the wearer and must be worn properly. Note that facial hair can make the respirator ineffective.

Some people with medical conditions should not wear respirators, nor should they do work that requires them. It's best to check with a medical professional to be sure it's safe to wear a respirator for more than a short time. Anyone with allergies or asthma should not work in moldy or heavy debris areas.

**Feet:** Wear rubber boots (in wet areas) or disposable non-skid shoe covers over work boots that have a steel toe and thick, hard sole.

**Head:** Wear a cap with a brim or other protective head cover. Wear a hard hat if there is a chance of falling debris, bumping your head, and when working on the roof or tall ladders.

**Hands:** Wear strong, waterproof gloves designed to protect hands from cuts, chemicals, temperature extremes, and abrasions.

**Body:** Wear disposable coveralls with elastic wrists and ankles. If you can't obtain disposable coveralls, bring a set of work clothes and shoes to the worksite. Change into them before entering the work area, and remove them before going home. Wash work clothes separately from other clothes. Wet-wipe work shoes (including the soles) and then throw away the wipes.



**PHOTO:** Rubber boots reduce electric shock hazard in wet conditions.

**When should I wear personal protective equipment (PPE)?**

- ▶ Put on the appropriate personal protective equipment (PPE) before you approach a damage area and keep it on. Full PPE to protect lungs, eyes and skin should be worn in areas that could contain mold, lead, asbestos or other contaminants.
- ▶ Inspect your PPE before each use to find any holes or other damage. If there are any flaws, replace it.
- ▶ When taking breaks or leaving, remove your PPE in the work site clean-up area. **Your respirator should be the last PPE item to take off.**
- ▶ Make sure to wipe and wash off your hands and face before removing your respirator, eating, drinking, smoking, or any other activities to avoid ingesting the contaminants you contacted. If a shower is available, use it after remediation activities.

**ILLUSTRATION A**  
**Personal Protective Equipment (PPE)**



**Full Professional Level PPE**  
(Recommended for high-hazard work)

1. Hard hat
2. Hearing protection earmuffs
3. Safety goggles
4. NIOSH-approved P100 half-face respirator
5. Disposable suit
6. Chemical-resistant gloves
7. Rubber boots with safety toes
8. Disposable shoe covers



**Minimal Personal Protective Equipment (PPE)**

9. Cap or hat with brim
10. Earplugs (if needed)
11. Safety goggles or glasses
12. NIOSH-approved N95 or N100 mask respirator
13. Removable work clothes (long sleeves and pants)
14. Rubber gloves
15. Rubber boots (wet work) or safety toe work shoes (rinsable)

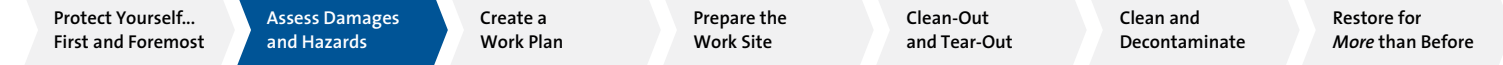
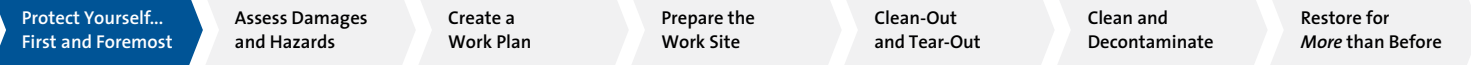

### What should I avoid when wearing/selecting my personal protective equipment (PPE)?

- ▶ Avoid gloves that are too thick or too large so you can safely handle objects.
- ▶ Don't wear sneakers or sandals, even with shoe covers. They won't prevent cuts, punctures, or crush injuries to feet.
- ▶ Don't wear hard hats backwards.
- ▶ Don't loosen your respirator to make it more comfortable. Bypassing the filter defeats its purpose.
- ▶ Keep in mind that contaminants may cling to hair and clothing and transfer to car seats. That could create an ongoing source of exposure to family and friends.
- ▶ Do not handle food or beverages with work gloves.
- ▶ When wearing full coverage PPE, take extra measures to avoid heat exhaustion in hot weather or hot areas.

### ACCIDENT PREVENTION

After a disaster, serious injuries from using chainsaws and power tools and from falls are common. Take the time to inspect and service power tools and ladders, review manufacturer instructions, and practice using them safely to build skill beforehand.

If you need to use a chainsaw to clear tree damage from your home or yard, use these safety tips to avoid an unplanned visit to a hospital emergency room:

- ▶ Operate, adjust, and maintain your chainsaw according to manufacturer's instructions. Check and adjust the tension of the chain saw blade.
- ▶ Wear personal protective equipment, including a hard hat, safety glasses, hearing protection, heavy work gloves, and cut-resistant legwear.
- ▶ Avoid contact with power lines.
- ▶ Always cut at waist level or below.
- ▶ Be sure that bystanders are at a safe distance from cutting activities.
- ▶ With an electric chain saw, use extreme caution to avoid electrical shock. Use a heavy-duty, 3-wire, outdoor extension cord; don't use it while standing in a wet area; and take care to not cut through the cord.
- ▶ Take extra care in cutting trees or branches that are bent, twisted, hung up on, or caught under another object. If the tree or the branch is suddenly released, it may strike you or a bystander.

## Assess Damages and Hazards

Review the common damages for the type of disaster that impacted you to anticipate what to look for and prepare. Regardless of the type of disaster, before you tackle any clean-up and restoration, damages and hazards should be carefully evaluated, including the following:

- ▶ Assess structural stability
- ▶ Inspect for creatures, chemicals and bio-hazards
- ▶ Inspect utilities – electrical, gas and water
- ▶ Inspect heating and cooling system (HVAC)
- ▶ Assess health hazards.

### ASSESS STRUCTURAL STABILITY

Most buildings that suffered structural damage will show distinctive outward signs. **Never enter a building that might have structural damage.** Review the information below about how to tell what is wrong and what to do.

#### What should I look for?

Evidence of structural damage may include:

- ▶ Roofs that sag in the middle or at the ends due to load-bearing walls that have shifted
- ▶ Walls that are not vertical or straight, and stuck doors
- ▶ Missing or broken support columns or beams
- ▶ A shift or separation where the structure meets the foundation
- ▶ New cracks in the exterior of the building or its foundation
- ▶ Continuous cracks or leaning of basement walls, crawl space walls, or piers
- ▶ Floors that sag, have separated from the walls, or have holes.

#### What should I do about it?

If you see any of those structural damage indicators, assume that the building is unsafe. Don't climb onto or go into the building until it has been verified by a qualified professional as safe to enter.

### ... COLLAPSE WARNING SIGNS

Leave the property immediately if you hear noises from shifting debris, see dust clouds, see changing crack patterns, or hear sounds such as creaking and crackling.

ILLUSTRATION B  
Structural Flaws

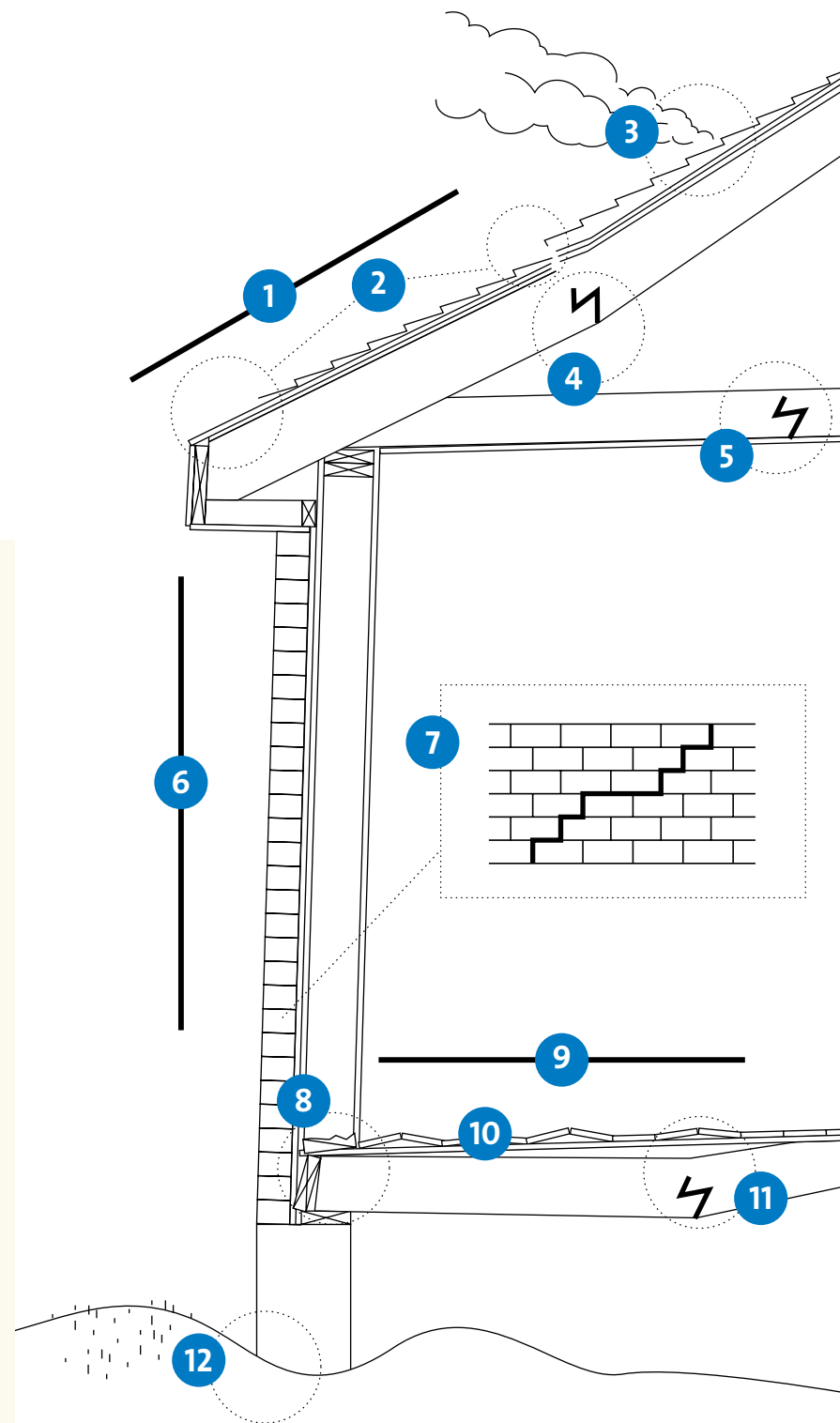

1. A sagging roof ridge or dip in the roof
2. Damaged roofing, roof decking and flashing
3. Smoldering wood
4. Cracked or broken roof rafter or truss
5. Cracked or broken ceiling joist
6. Wall bulging or not straight
7. Stair-step or diagonal pattern of cracks in walls, particularly near bottom
8. Rotten or displaced bottom plate, rim board, or sill beam.
9. Floors and ceiling joists not level
10. Buckled or broken floor boards
11. Cracked floor joist
12. Sunken, broken or leaning foundation

Protect Yourself...  
First and Foremost

Assess Damages  
and Hazards

Create a  
Work Plan

Prepare the  
Work Site

Clean-Out  
and Tear-Out

Clean and  
Decontaminate

Restore for  
More than Before

Even if the building is verified as structurally sound to enter, remain alert to dangerous walking and working surfaces, such as:

- ▶ Cracks, buckles, voids and weakened spots in the floor
- ▶ Slippery conditions
- ▶ Sharp debris such as broken glass and splintered wood
- ▶ Debris piles that could collapse
- ▶ Sagging ceilings that may contain water or wet insulation that might collapse
- ▶ Smoldering material that might reignite.



PHOTO: Remain alert to hazardous walking and working conditions.

**Should I bring in a professional?**

Never enter a building that might have structural damage until it has been inspected by a local official, engineer, or professional home inspector. If there is structural weakness, hire a licensed contractor or engineer to design and install reinforcements (unless the building is condemned and must be demolished). Get a building permit and inspections of the corrective work.

Check with your local building permit office to find out about any residential damage assessment programs and procedures. They may have a post-disaster inspection and rating system, such as:

- ▶ **GREEN:** Building is safe to enter and occupancy is permitted.
- ▶ **YELLOW:** Building has potential structural damage and/or failing non-structural items or accessories (like a porch or deck). Building may or may not be habitable; partial occupancy is permitted per noted restrictions.
- ▶ **RED:** Building is unsafe to enter and its occupancy is prohibited. The building is structurally unstable and may collapse.

**INSPECT FOR CREATURES, CHEMICALS AND BIO-HAZARDS**

**What should I look for?**

- ▶ Just as people are displaced during disasters, so too are animals and insects. Snakes, rats, mice, cockroaches and other pests tend to hide in debris. Standing water breeds mosquitos. In the south, watch out for fire ants. They can float and survive on floodwater.

**SAFETY TIP:**

If a home was damaged by fire, or if combustion equipment (such as a gas furnace or water heater) is damaged, keep two fire extinguishers with a UL (Underwriters Laboratory) rating of 10ABC nearby at all times.



- Protect Yourself... First and Foremost
- Assess Damages and Hazards
- Create a Work Plan
- Prepare the Work Site
- Clean-Out and Tear-Out
- Clean and Decontaminate
- Restore for More than Before

- ▶ Disasters often result in toxic chemical and fuel spills. Industrial, agricultural and household chemicals can be released into the air or floodwater and leave a hazardous residue on materials. Find out about major sources of chemicals in your area.
- ▶ Consider rising floodwater to be contaminated. It's likely to contain sewage and infectious bacteria, in addition to chemicals. Tetanus, commonly known as lockjaw, can be acquired from contaminated soil or water that gets on broken skin, like a cut or scrape.

**What should I do about it?**

- ▶ Look before you leap! Expect hidden hazards and plan accordingly. Wear protective gear.
- ▶ Tap the floor and piled debris with a long stick ahead of your path to reveal hiding creatures.
- ▶ If you see a snake or other dangerous animal, back away slowly, then call local animal control.
- ▶ Listen for alerts from authorities about chemical releases or hazards.
- ▶ Wash skin exposed to hazardous chemicals or bacteria. Keep a first aid kit handy.
- ▶ Do not let children play in floodwater or debris.

**Should I bring in a professional?**

- ▶ Report major chemical and fuel spills to local authorities or to the U.S. EPA National Response Center at 1-800-424-8802.
- ▶ If anyone shows signs of illness or infection, immediately see a health professional and describe the exposure. If you suspect poisoning, call 911 or the National Poison Control Center at 1-800-222-1222.
- ▶ Note: People with hearing or speech disabilities may reach these phone numbers through the Federal Relay Service teletype service at 800-877-8339. Visit [www.gsa.gov/fedrelay](http://www.gsa.gov/fedrelay) for additional ways to communicate with federal agencies.

**INSPECT UTILITIES – ELECTRICAL, GAS AND WATER SUPPLY**

**What should I look for?**

- ▶ **CAUTION!** Be aware of power lines, power junctions and downed electrical wires. They can cause electrocution and burns. Make sure that no live electric lines are on the property or in the house.
- ▶ Find out if there is a natural gas line or fuel tank, and check for damage. If you smell gas, assume the area is unsafe.
- ▶ Look for water streaming out of the home from a plumbing break.
- ▶ Find out if the community water supply is safe to use and to drink.

**What should I do about it?**

- ▶ Notify the electric company of damaged and downed power lines. Do not touch fallen wires.
- ▶ Shut off any gas supply to the building. Turn off the shut-off valve at the gas meter or propane tank; you may need a wrench or pliers.

**ILLUSTRATION C  
Shutting Off Utilities**

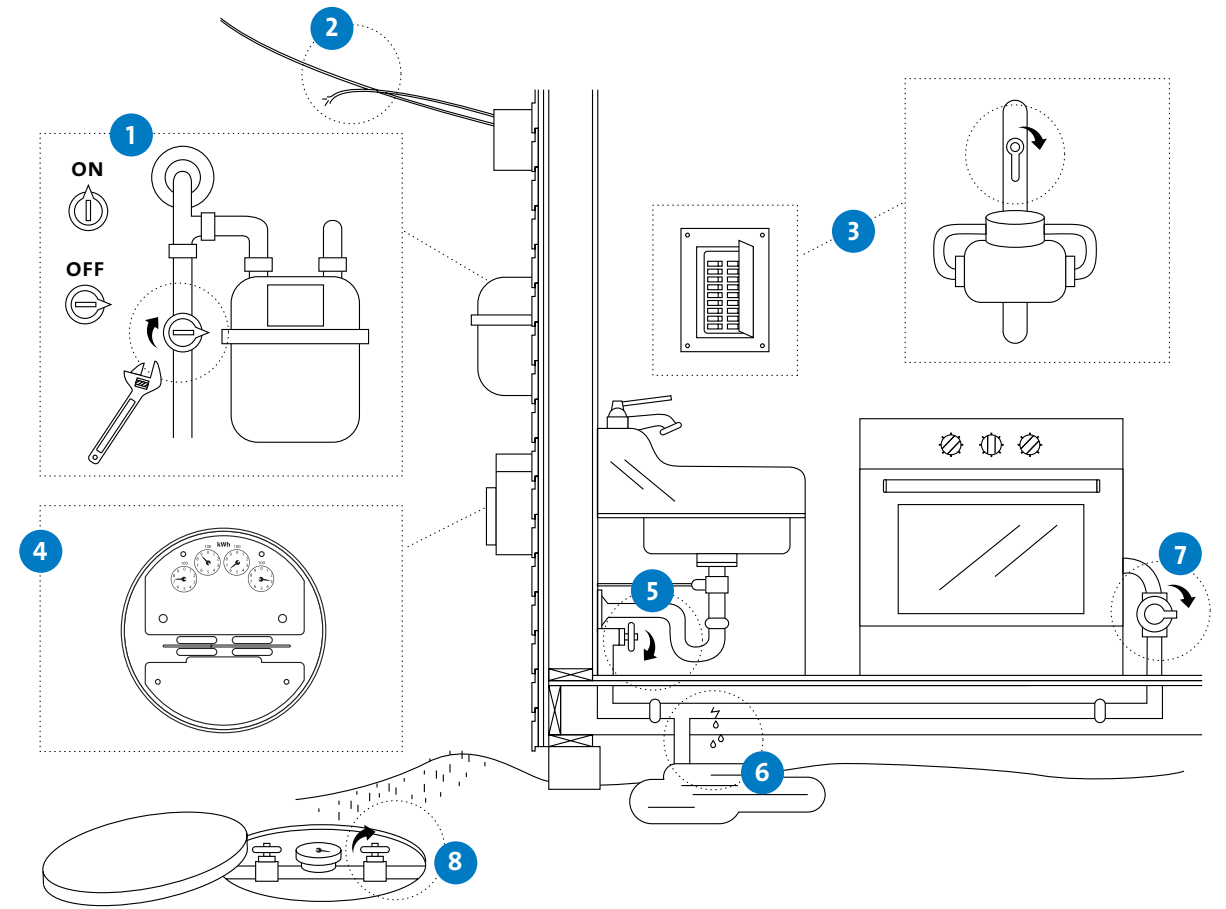

- 1. Gas meter:** Check gas meter or fuel tank to be sure valve is off. You may need a wrench.
- 2. Power lines:** Report any down, loose or damaged power lines or wires.
- 3. Electric box or panel:**
  - If exterior electric box (common on older homes), place handle in off position (down). Secure or label it to prevent accidental activation.
  - If no exterior shut-off, turn off the main circuit breaker switch or remove fuse in electrical panel.
  - **CAUTION!** Do not touch electrical panel while standing in water or if it is damaged. Get an electrician to shut off power.
- 4. Electric meter:** Before entering, make sure there is no dial movement on electric meter.
- 5. Water valves:** Turn off water valve (clockwise) of each sink, toilet, water heater, ice maker, etc.
- 6. Drains:** Pour bucket of water into sinks, toilets and tubs to check for leaks.
- 7. Gas appliances:** Turn off all valves to gas appliances. Valve handles should be perpendicular to pipe.
- 8. Water meter:** Find and turn off main water shut-off valve at meter (may be in the front yard). You may need a wrench. Call the water district office if you can't find or reach the valve.

Protect Yourself...  
First and Foremost

Assess Damages  
and Hazards

Create a  
Work Plan

Prepare the  
Work Site

Clean-Out  
and Tear-Out

Clean and  
Decontaminate

Restore for  
More than Before

- ▶ Open all windows when you enter a building to clear the air. If you smell gas or hear a noise that sounds like escaping gas, leave immediately. Also leave the door open and notify the gas company.
- ▶ Never create any ignition until you are 100% sure that there is no gas in the air. That means do NOT smoke, light matches or lighters, operate electrical switches or flashlights, use telephones or mobile phones, or start a car.
- ▶ Turn off all electricity at the main electrical panel, but NOT while standing in water. Then, unplug appliances and lamps, remove light bulbs from fixtures, and remove the cover plates of any wall switches and outlets that got wet.
- ▶ Visually inspect equipment before use. Label or remove damaged items.
- ▶ When power is turned back on, make sure the circuits and electrical equipment are grounded. Never use an electric tool or appliance while standing in water or a wet area.
- ▶ If there are plumbing leaks or the water supply might be contaminated, turn off the main shut-off valve with a wrench. Do not use contaminated water for clean-up.
- ▶ Test or install carbon monoxide (CO) detectors and smoke alarms in the home. When there's no power, get a battery-operated CO detector, if using any fuel-burning equipment.
- ▶ If anyone feels dizzy, weak or nauseated during work, get fresh air immediately. If symptoms persist, seek immediate medical help.



**PHOTO:** Carbon monoxide (CO) detector with digital read-out allows you to monitor CO levels.

#### **Should I bring in a professional?**

Have a licensed electrician inspect and repair the electrical system before using anything electrical, if any wiring was damaged or flooded, if the power supply is not grounded, or if the electrical path has been broken.

If there could be damage to gas lines (from floods, earthquake, fire, etc.) or if you smell gas, have the gas utility company inspect your service before using it. If there is damage, disconnect gas appliances or pipes.

### **INSPECT HEATING, VENTILATION, AND AIR-CONDITIONING (HVAC) SYSTEMS**

#### **What should I look for?**

Examine the heating and cooling units and ductwork or piping for damage, separations and soot. Check to see if any components were flooded. Look for signs of fire, rust, loose connections, and mold.

Protect Yourself...  
First and Foremost

Assess Damages  
and Hazards

Create a  
Work Plan

Prepare the  
Work Site

Clean-Out  
and Tear-Out

Clean and  
Decontaminate

Restore for  
More than Before

#### **What should I do about it?**

- ▶ Combustion equipment (gas or oil furnaces, steam boilers, wood/pellet burning heaters), flues and fuel lines should be inspected by an equipment professional or the fire department. This is needed after any event that could potentially cause a hidden crack or separation, even if you can't see any damage.
- ▶ When the heating or cooling system is turned on, if it makes an unusual noise, or emits odor or sparks, turn it off. Do not use it until checked by an HVAC equipment professional.
- ▶ Before the home is occupied, try to run the HVAC system for two or three days. This avoids exposure to the "first flush" of residue that may be in the system, and provides a trial run.

#### **Should I bring in a professional?**

A heating/ventilation/air conditioning (HVAC) professional should inspect, clean, and test the performance of a potentially damaged or soiled HVAC system. A complete clean-up of flooded or moldy HVAC components should include the following procedures:

- ▶ All flooded filter media and insulation in components should be removed. This might require cutting into or replacing insulation-lined ducts and components.
- ▶ Only a high efficiency particulate air (HEPA) vacuum cleaner should be used to remove debris.
- ▶ If contaminated with floodwater, sewage or mold, components should be sanitized or replaced. Only HVAC-safe biocides should be used. **WARNING:** Chlorine bleach should NOT be used to disinfect HVAC equipment or any metals, since it is corrosive.
- ▶ After cleaning, components should be dried and tested before use.
- ▶ Combustion equipment should be tested for gas leaks, exhaust leaks and backdrafting (reverse flow of combustion gases into the home).

### **ASSESS HEALTH HAZARDS**

#### **Mold**

Molds are a type of fungi. They serve as nature's recycler by helping to break down dead materials. That's a good thing in nature, but not in our homes and bodies.

Molds produce tiny spores that float and spread easily through the air. Live spores act like seeds, forming new mold growths (colonies) when they find the right conditions – moisture, nutrients and a suitable place to grow. Of these, moisture is the key factor – for growth and for control.

That means **the solution to mold control is moisture control**. Mold growth begins on materials that stay wet for about two to three days and can multiply rapidly. After a wetting event, rapid drying can prevent a mold population explosion. When that's not possible and mold growth has occurred, it's still important to deal with it as soon as possible using safe and effective methods.

#### **What are the hazards of mold?**

Although there is wide variation in how mold affects people, long-term or high exposure is a health hazard for anyone.

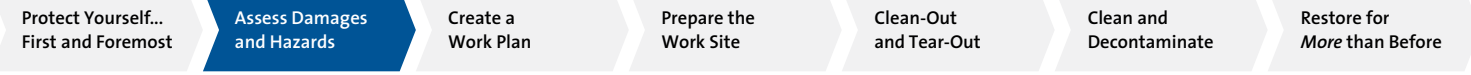

- ▶ Breathing in mold spores can trigger allergic reactions and asthma attacks. Contact with mold can cause skin and eye irritation. Exposure may lower resistance to illness, especially in combination with other health hazards.
- ▶ Some types of mold can produce toxic substances that are present in both live and dead spores and fragments.

Mold growth can also stain and damage materials. It can't penetrate the surface of solid wood, but it can damage other porous materials, especially composite wood products, paper and fabrics.

**CAUTION! Don't enter a moldy house without suitable protective gear. Wear a respirator rated at least N95 (N100 is preferred), goggles and gloves. Do not touch moldy materials with bare hands.**

**What should I look for?**

- ▶ Telltale signs include discoloration and fuzzy growth on surfaces, or a musty odor (which indicates active growth). Mold may appear as cottony, velvety, granular, or leathery. It may appear white, black, brown, green or orange.
- ▶ Locate all areas that got wet, even if they now appear dry. Look for visible signs of mold growth. Anything that stayed damp longer than two days is likely to have mold.
- ▶ It is helpful to use a moisture meter with a probe or scanner to check for hidden dampness. Moisture meters are available at many home improvement stores and online.
- ▶ Investigate areas with musty odors and seek out hidden mold growth behind, above or underneath materials such as wallpaper, drywall, paneling, flooring, ceiling tiles, cabinets, etc.
- ▶ If there is fibrous or open cell foam insulation in walls or ceilings that got wet, expect mold growth. Those materials hold water and impede drying.



**PHOTO:** Mold can appear cottony white.



**PHOTO:** Moisture meter.



**PHOTO:** Mold growth in flooded home.

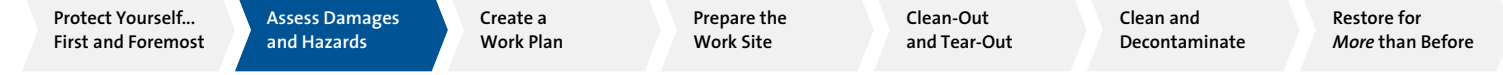

... MOLD MYTHS ...

**MYTH: "Black mold" is the dangerous type.**

**FACTS:** Many species of mold are black. That term was coined to describe one species that was suspected of causing serious health effects. Regardless of color or species, any indoor mold growth should be considered a potential health hazard and safely removed.

**MYTH: I see mold in my home, so I need mold testing.**

**FACTS:** Mold testing in a home is not usually needed or useful (unless required by a doctor, insurance policy or remediation contractor). If you see or smell mold, you have mold! Regardless of the type or quantity, it should be removed, and the sooner the better.

**MYTH: I only need to test for and remediate "toxic mold."**

**FACTS:** Any type of mold is a potential health hazard and should be removed. Some species (including common indoor molds) can produce toxins in certain conditions. However, most tests don't detect whether or not toxins are present, so testing is not usually helpful to answer health concerns.

**MYTH: Bleach should be used to kill mold.**

**FACTS:** Dead mold and live mold can have the same health effects, so it's best to remove mold rather than just kill it. Bleach and other disinfectants can kill mold if in contact long enough, but are hazardous chemicals that also pose risks to people and some materials. See the *Clean and Decontaminate* section to learn more.

... FLOODING AND MOLD GROWTH ...

- ▶ Roof damage can result in water and mold damage to ceilings, insulation and walls.
- ▶ Wet drywall is more prone to mold growth than is plaster.
- ▶ Wet carpets and pads slow drying, warp subflooring.
- ▶ High indoor humidity encourages mold growth, slows drying.
- ▶ Vinyl wallpaper traps moisture in walls.
- ▶ Water settles on bottom wood framing, and risks mold and decay if it stays wet behind baseboard.
- ▶ Wet insulation (except for closed cell foam) holds water, causing long-term mold and rot problems. It MUST be removed.

1. Wicking water line – Water wicks upward beyond the flood level. Extreme mold growth from long-term wetness is worse in wicking area.
2. Floodwater line – Shows depth of flood.



**PHOTO 1:** Mold and rot from leaving wet insulation in wall.



**PHOTO 2:** Ceiling damage resulting from roof leaks.

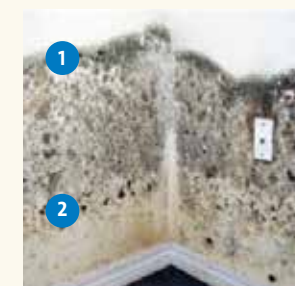

**PHOTO 3:** Mold growth is heavier in wicking area (above flood level).



**PHOTO 4:** Mold behind vinyl wallpaper.

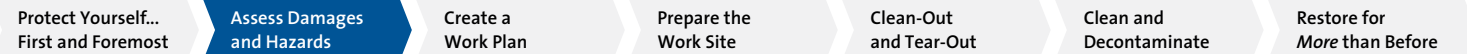

**What should I do?**

- ▶ The longer mold is allowed to grow, the faster it multiplies, the greater the health hazard, and the harder it is to remedy. So as soon as it's safe to enter, **don't delay clean-up and dry-out**. Do not wait for an insurance claims adjuster to see it; take photos and get started as soon as you can.
- ▶ To protect your health and home, make sure the mold clean-up process is done as safely and thoroughly as possible. Whether you hire a pro or must tackle it yourself, make sure everyone follows recommended mold removal guidelines or nationally recognized standards.
- ▶ See **10 Steps for Safe and Effective DIY Mold Removal** in the *Clean and Decontaminate* section of this guide for do-it-yourself guidelines. Learn more at [www.epa.gov/mold](http://www.epa.gov/mold).

**Should I bring in a professional?**

- ▶ Hiring a properly trained and equipped mold remediation contractor can provide the safest and most effective result. However, that's often not an option for many disaster victims. After floods, mold remediators may be in short supply. Homeowner's insurance typically doesn't cover the cost of mold removal. Check your policies.
- ▶ Before hiring a contractor, check your state or local government's licensing, registration or certification requirements. Get in writing the cost and the methods or recognized protocol to be used.
- ▶ Professional contractors may use mold sampling before and after remediation to verify the effectiveness of their clean-up work. This is referred to as "clearance."

**Lead in Paint, Dust and Soil**

The most common sources of lead poisoning are from lead-contaminated paint, dust and soil – through breathing in dust and hand-to-mouth ingestion. The greatest risk is to young children and pregnant women, but lead is harmful to anyone.

- ▶ Even tiny amounts of lead dust can cause irreversible damage to children's development, causing learning disabilities, lower I.Q., behavioral problems and stunted growth.
- ▶ High levels can cause mental retardation, coma, and even death.
- ▶ In pregnant women, lead poisoning can cause miscarriages, premature births, and stillbirths.
- ▶ In any adult, lead can cause high blood pressure, fertility problems, digestive problems, joint pain, and memory problems.

**What should I look for?**

If your home was built prior to 1978, it could contain lead-based paint. The older the home, the more likely it has lead-based paint. It was most commonly used on painted woodwork and trim, windows, kitchen and bathroom walls, and exterior surfaces like siding and trim.

Soil, especially near major roads and in cities, can contain lead from leaded gasoline fumes of the past. It could also contain lead-based exterior house paint dust from past chalking and sanding.

- ▶ If the home or its painted or varnished furnishings were built prior to 1978 (or you don't know the age), and a certified lead inspector has not determined that it's lead-free, then assume there is lead-based paint.

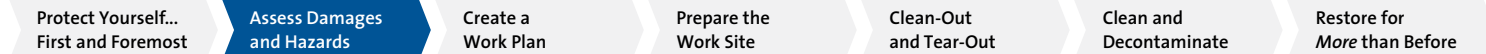

- ▶ Look for damage to any painted materials. Any peeling, cracked, blistered or eroded paint creates lead-based dust that can float in the air and settle on any surface.
- ▶ If wind-driven dirt or silt from floodwater was deposited in the home, assume it contains lead.

**What should I do about it?**

Learn more about lead-safe work practices before you begin work. Free information is available at [www.epa.gov/lead](http://www.epa.gov/lead) or by calling the National Lead Information Center at 1-800-424-LEAD (5323).

Note: People with hearing or speech disabilities may reach this phone number through the Federal Relay Service teletype service at 800-877-8339. Visit [www.gsa.gov/fedrelay](http://www.gsa.gov/fedrelay) for additional ways to communicate with federal agencies.

If lead-contaminated soil or paint might be present:

- ▶ Keep children and pregnant women away from any area that might have lead dust or debris.
- ▶ Try to avoid spreading and disturbing lead-contaminated dust.
- ▶ Do not burn painted materials and debris, unless you know they are lead-free.
- ▶ Make sure that you and all workers use lead-safe work practices, including:
  - Wear personal protective equipment (PPE), including an N100 respirator (half-face type with purple cartridges is preferred), goggles and gloves.
  - Cover work areas with plastic sheeting to catch paint debris from restoration activities.
  - Minimize pounding and hammering (pry and pull instead). Avoid using sandblasting, heat guns or torches. Avoid chemical paint removers since they pose additional health risks.
  - Use wet methods in deconstruction and demolition. Wet-mist an area before drilling, cutting or scraping.
  - If using power tools or sanders, a HEPA filter vacuum attachment is needed.

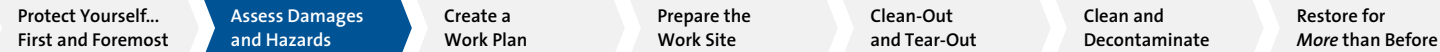

**PHOTO:** Do NOT sand lead paint. Use removal methods that control dust.



**PHOTO:** Wet-misting lead paint reduces dust hazard.





- Collect and seal paint and renovation debris in plastic bags or tarps for disposal.
- Damp clean to pick up settled dust. Follow up with a HEPA vacuum, if possible.
- Following repair, make sure the building has been thoroughly cleaned. Get a lead dust cleaning verification test or a clearance examination, if possible, by a certified lead professional (see below).

Note: If you receive government rental or homeownership assistance for your pre-1978 house or apartment, a clearance examination by a certified lead risk assessor or inspector is usually required before the home can be reoccupied. Contact the agency providing the housing assistance for information. Find certified lead risk assessors or inspectors near you through [www.epa.gov/lead](http://www.epa.gov/lead) or by calling the National Lead Information Center at 1-800-424-5323. People with hearing or speech disabilities may reach these phone numbers through the Federal Relay Service teletype service at 800-877-8339. Visit [www.gsa.gov/fedrelay](http://www.gsa.gov/fedrelay) for additional ways to communicate with federal agencies.

#### **Should I bring in a professional?**

If you use contractors to make repairs on a pre-1978 home, hire only EPA- or state-certified Lead-Safe Renovators since they have completed special training in lead-safe work practices to protect your health. A lead dust test or inspection can be performed by an EPA- or state-certified Lead Inspector or Lead Risk Assessor. You can search for certified firms at [www.epa.gov/lead](http://www.epa.gov/lead) or call the National Lead Information Center number above.

Homeowners working on their own homes do not have to be certified, but contractors who work on pre-1978 homes are required by the EPA Renovation, Repair and Painting (RRP) Rule to be certified. The rule has some emergency exemptions for work on disaster-damaged property to allow work to happen quickly.

#### **Asbestos**

Asbestos is a mineral fiber that was used in many building products because of its heat resistance and strength. Some materials installed in homes, especially those built before 1980, contain asbestos. When damaged or disturbed, tiny fibers can be released into the air and become a health hazard. The fibers can be small enough to be invisible to the naked eye.

- ▶ Breathing asbestos fibers can increase risk of developing lung cancer and other serious lung diseases. The risk increases with the number of fibers inhaled and if you smoke, but symptoms may not appear for many years.
- ▶ Asbestos in a home is usually not a problem if the material is in good condition. However, it's a big concern following disasters because damage to building materials can expose and release asbestos fibers.



**PHOTO:** Asbestos is a naturally occurring mineral that was used in many materials before 1980.

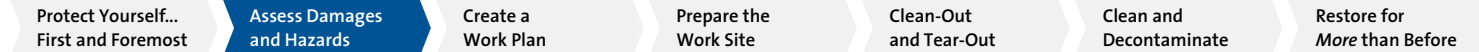

#### **What should I look for?**

Some pre-1980 materials that may contain asbestos include:

- ▶ Steam-pipe, boiler, furnace and duct insulation
- ▶ Fireproofing materials around heat sources
- ▶ Soundproofing, ceiling tiles and spray-on acoustic or fireproofing coatings
- ▶ Textured paints
- ▶ Plaster, cement, putties and caulk
- ▶ Asbestos and vinyl/asbestos floor tiles, backing, mastic and adhesives
- ▶ Asbestos cement siding and roofing
- ▶ Artificial ashes in gas fireplaces
- ▶ Heat-resistant textiles.

If you're unsure if your home was built before 1980, assume these materials might contain asbestos. Only certified asbestos inspection professionals can determine whether a material contains hazardous asbestos.

If there might be asbestos, wear a properly fitted N100 or P100 respirator. Consider that:

- ▶ Floods can break down stable asbestos into hazardous fibers
- ▶ Smoke from burned debris can contain asbestos fibers
- ▶ Wind and earthquake forces can damage asbestos materials and release fibers.

#### **What should I do about it?**

**If an asbestos material is in good condition with no damage, leave it alone.** It's better to not disturb it. Take precautions to avoid further damage during restoration activities.

If asbestos materials are damaged, there are two types of correction – repair or removal:

**Repair** involves either sealing or covering asbestos material to keep it in place and prevent fibers from being released into the air. It is usually safer and lower cost than removal.

- ▶ **Sealing** (encapsulation) involves treating the material with a product that either binds the asbestos fibers together or coats the material so fibers are contained. It is the typical remedy for pipe, furnace and boiler insulation. This is not a viable do-it-yourself procedure and should be done by a qualified professional trained to handle asbestos and safely apply the appropriate sealant.
- ▶ **Covering** (enclosure) is placing a protective wrap or new material over and around the asbestos material to prevent release of fibers into the air. Covering avoids further disturbance of the material. Laying new flooring over asbestos floor tile is a common and practical solution.

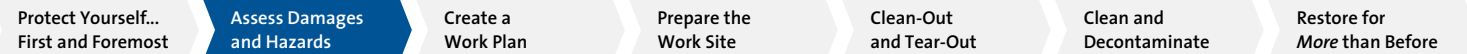

**Removal** is usually more risky and expensive than repair, since it further disturbs the material which can result in the release of more fibers. When removing damaged asbestos-containing materials, make sure the following precautions to minimize health risks are used.

- ▶ Wear proper personal protective equipment (PPE) and don't allow anyone without PPE near the work area. Post a warning sign, "Danger Asbestos Dust Hazard – Cancer and Lung Disease Hazard – Authorized Workers Only."
- ▶ Seal off the work area to prevent spread of asbestos to other rooms. See *Set Up Containment* section ([pages 39 to 40](#)).
- ▶ Apply a wetting agent (such as water and a few drops of detergent) with a fine mist hand sprayer. Wet fibers don't float well in air and are easier to clean up.
- ▶ Avoid sanding, scraping or drilling holes in asbestos-containing materials.
- ▶ Remove whole pieces or ensure that fragments to be removed are as large as possible.
- ▶ Never sweep debris. Vacuum only with a HEPA vacuum cleaner made for asbestos removal.
- ▶ Keep debris wet, double-bag, label and seal it in heavy duty plastic bags for proper disposal.

**Should I bring in a professional?**

Private homes usually are not covered by asbestos regulations, but you should make sure that qualified asbestos professionals handle any repair or removal of damaged asbestos materials. That could be a certified asbestos abatement contractor or, when appropriate, a professional trained to handle specific products (such as asbestos flooring, roofing or plumbing). If possible, when the work is completed, have the asbestos professional test the indoor air to ensure it's safe before the home is occupied.

**Radon**

Radon is a radioactive gas that comes from the break-down of uranium in soil. It can be released into the air, seep into homes and build up to hazardous levels. Radon can be found all over the U.S., but some areas have high radon levels. See EPA's Map of Radon Zones at [www.epa.gov/radon/zonemap.html](http://www.epa.gov/radon/zonemap.html).

Radon is the second leading cause of lung cancer in the U.S. after smoking. Most radon-induced lung cancers occur from long-term low and medium dose exposure in homes. If you smoke and your home has high radon levels, your risk is especially high. Learn more about radon at [www.epa.gov/radon](http://www.epa.gov/radon).

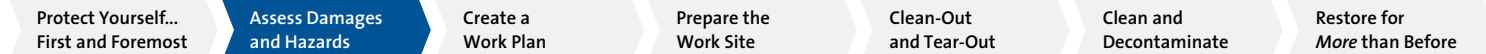
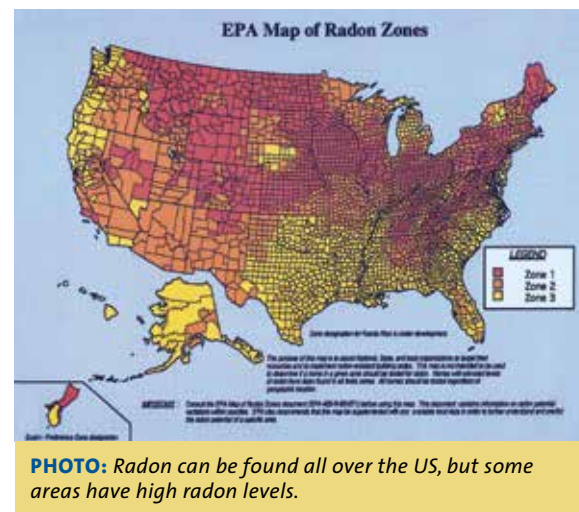

**What should I look for?**

You can't see, smell or taste radon. The only way to know if you are at risk from radon in your home is to test the indoor air using a radon test kit. Note that a radon test requires that windows and doors be closed as much as possible during the several-days long test, so testing a severely damaged home may need to wait until after repairs.

Damage to your home's foundation, basement or sump pump could increase the risk of radon entering the home. Inspect for cracks, gaps and signs of shifting. Also inspect walls (interior and exterior) for diagonal cracks, gaps or bulges that may have been caused by foundation damage.

Many newer homes, especially in high radon risk zones, have radon mitigation, or reduction, systems. Such a system is likely to be labeled. It may include soil gas exhaust pipes inserted through or under the foundation floor, with or without an exhaust fan. The pipe from (from foundation to roof) should be checked for signs of damage. Also make sure that its seal to the foundation is unbroken and airtight.

**What should I do about it?**

The EPA recommends radon testing for all homes, regardless of the risk zone. Testing to see if a radon mitigation system should be included in your restoration plan is inexpensive and easy. If your home is not badly damaged and can be kept mostly closed for a few days, test the basement if it is used frequently; otherwise test the first floor for radon before you repair your home. Installing a radon system during rehabilitation work can be easier and less expensive than adding it later.



**PHOTO:** Testing to see if a radon mitigation system should be included in your restoration plan is inexpensive and easy. Radon test kits are available from home improvement stores.

- ▶ Radon test kits are available from home improvement stores. When using a short term test, keep all windows and doors closed for at least 12 hours before the test and as much as possible during the test (2-3 days). It's okay to run a heating or cooling system that circulates indoor air during the test period, but don't run exhaust fans or equipment that bring in outside air. Do not do the test during severe storms with high winds. Follow test package directions carefully.
- ▶ The EPA recommends fixing a home when the radon level is 4 picocuries per liter (pCi/L) or higher. To lower your risk even further, you may want to consider radon reduction if the reading is above 2 pCi/L.

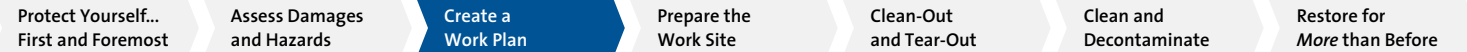

- ▶ See the *Restore for More than Before – Healthy Home Improvements – Keep It Contaminant Free* section of this guide for methods to add radon resistance to a disaster damaged home.

Any damage to the foundation, basement, crawl space or radon mitigation system (if applicable) should be repaired. Even minor cracks, gaps and crevices in a concrete slab or in the walls of an enclosed (not vented to the outside) basement or crawl space should be sealed, even if not a structural concern.

### Should I bring in a professional?

A radon reduction system requires special knowledge and skills. You should use a qualified contractor who is trained to fix radon problems and help you choose the right system. Check with your state radon office for qualified radon contractors in your area (see [www.epa.gov/radon/whereyoulive.html](http://www.epa.gov/radon/whereyoulive.html)).

## Create a Work Plan

### What should I do before beginning work on a damaged home?

A thoughtful work plan saves time, cuts hassle, smoothes progress and protects the health and wellbeing of all involved. Consider the following components in your plan.

### Supplies and Materials

Make a list of all the supplies and materials you will need and buy as much of them ahead of time as you can. It may be easiest to find supplies outside the disaster area. See Appendix 1 for a general list of supplies and materials. Other items may be needed for your specific home.

Ensure that deliveries and workers will be able to find your address. If street signs or address markers are missing, paint your home's address on the pavement or erect a sign.

**IMPORTANT!** If exterior materials are damaged or missing, **temporary weather barriers** should be installed as soon as possible to prevent water intrusion that could cause further damage. Plan what temporary protections are needed (see *Prepare Work Site* section) and arrange for installation. If there was a disaster declaration, find out if you are eligible to have a tarp or other weather barriers installed through FEMA disaster assistance programs. Contact your local emergency management office to find out.

### Electricity

When electricity is not available soon enough, you may want to arrange for a portable generator. Get specialized gasoline cans designed for safely storing gasoline to refuel the generators.

#### Important:

Be sure all permits and approvals are obtained before construction begins!

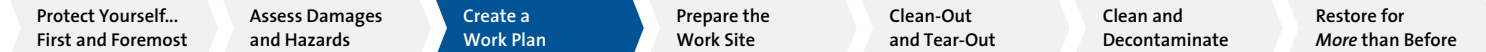

**CAUTION!** Never use gasoline-powered generators indoors. They create a major carbon monoxide hazard that can be deadly. They can also pose a fire risk. Plan to place them outside as far from the building as possible, and at least 10 feet away from all building openings. Learn more about portable generator safety at [www.osha.gov](http://www.osha.gov).

Solar power generator kits are now available online and at some home improvement centers. Small solar chargers can recharge mobile phones, lanterns and some rechargeable power tools. Portable high-capacity solar generator kits can provide up to 1,800 watts of power. This could provide a safer and more convenient alternative to gasoline generators, since they don't need fuel and don't produce combustion pollutants. After a major disaster, gasoline can be hard to get.

If the home has electricity, it's safest to have an electrician install a GFCI (ground fault circuit interrupter) outlet box for running the cleaning and restoration equipment. Shut off all other electricity until conditions are fully safe.

### Storage Areas

Determine where and how much clean storage space is needed for belongings that you are saving. Items that have been contaminated must be cleaned before placed into storage.

Set up a secure storage area to keep tools and supplies safe. Store supplies in an organized manner for convenience and safety. Store moisture-sensitive materials on pallets or above the ground.

### Disposal

Find out about your community's disaster debris disposal guidelines. Monitor the local media or check with your area's Department of Health, Sanitation or Waste Management. Waste should normally be sorted for special disposal or pick-up service (see *Site Layout* section below).

Hazardous waste needs special disposal and should be separated from other waste. Make sure that debris that has lead, asbestos or mold is wrapped or bagged (heavy-duty or double-bagged), sealed, labeled and disposed of in accordance with local, state and federal requirements. Construction waste, furniture, large appliances, and electronics may also have specialized disposal rules, especially after a disaster.









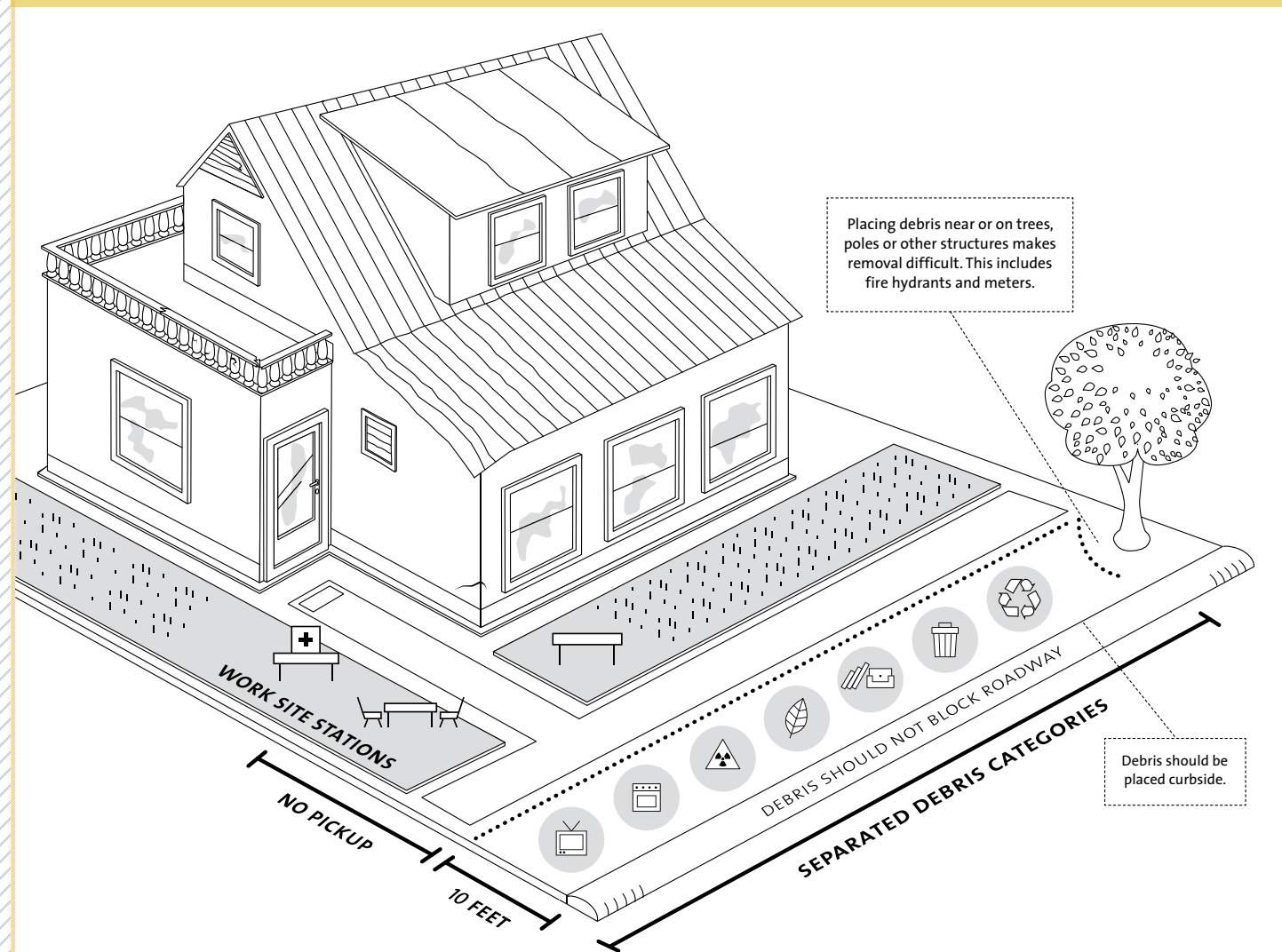

Ensure that your home debris is properly sorted and discarded. If your home does not receive collection service for large debris, make plans to rent a large waste container or have a contractor haul the waste to proper disposal sites.

### Site Layout

Draw a site plan layout of how to arrange work stations and sorted debris piles. Follow your community's guidance in sorting waste for disposal, since various types of items may be handled

ILLUSTRATION D  
Sample Site Layout



- |  |  |
|--|--|
|  <b>Salvaging Station</b> – to sort, clean and save possessions               |  <b>Electronics Disposal or Recycling</b> – computers, TV's etc.                  |
|  <b>Clean-up, Health and Safety Station</b> – away from damage and work areas |  <b>Large Appliances</b> – lock, tape or remove doors to prevent child entrapment |
|  <b>Break Station</b> – clean, comfortable area to rest and eat               |  <b>Hazardous Waste</b> (clearly labeled)   |
|  |  <b>Tree/Plant Waste</b> (near street for mechanical pick-up)                     |
|  |  <b>Building Material and Furniture Waste</b>                                     |
|  |  <b>Household Garbage</b>   |
|  |  <b>Recycle Bins</b> , if available   |

Protect Yourself...  
First and Foremost

Assess Damages  
and Hazards

Create a  
Work Plan

Prepare the  
Work Site

Clean-Out  
and Tear-Out

Clean and  
Decontaminate

Restore for  
More than Before

differently. As a general rule, place the debris piles curbside, within 10 feet of the street. Debris should not block pathways or roadways. Don't place debris near trees, poles or other structures that could make it difficult to remove.

Unless directed differently, designate separate areas for:

- ▶ A **salvaging station** to sort, clean, and save possessions
- ▶ A **break station** to rest in a clean, comfortable area away from work areas
- ▶ A **clean-up, health and safety station** away from damage and work areas
- ▶ **Electronics** disposal (potential for recycling or special handling of computers, TVs, etc.)
- ▶ **Large appliances** disposal (tape shut, lock or remove doors to prevent child entrapment)
- ▶ **Hazardous waste**, clearly labeled (pesticides, chemicals, fluorescent lamps, lead or asbestos debris, batteries, oil)
- ▶ **Plant/tree waste** (near street for mechanical pick-up)
- ▶ **Building material and furniture waste**
- ▶ **Household garbage**
- ▶ **Recycle bins**, if available (paper, aluminum, recyclable plastics).

### Selecting Qualified Contractors

#### Where can I find qualified contractors?

- ▶ Check your state's contractor licensing agency for lists of licensed or registered general and specialty contractors.
- ▶ Find certified Lead-Safe Renovators in your area at [www.epa.gov/lead](http://www.epa.gov/lead).
- ▶ Find a link to the agency in your state that lists asbestos professionals at [www.epa.gov/asbestos](http://www.epa.gov/asbestos) (see *Hire an Asbestos Professional*), visit [www.nachi.org/asbestos](http://www.nachi.org/asbestos), or contact your local Health Department. For accredited asbestos laboratories, visit [www.nist.gov](http://www.nist.gov) and select the Laboratory Accreditation (NVLAP) link under Products and Services.
- ▶ Check restoration industry groups that list professionals certified in cleaning, fire and water damage, mold remediation and related specialties, such as:
  - The Restoration Industry Association ([www.restorationindustry.org](http://www.restorationindustry.org))
  - The Institute of Inspection, Cleaning and Restoration Certification ([www.certifiedcleaners.org](http://www.certifiedcleaners.org))
  - The American Council for Accredited Certification ([www.acac.org](http://www.acac.org)).
- ▶ To find home builders and remodelers who are members of the National Association of Home Builders and its local chapters, visit [www.nahb.org](http://www.nahb.org). Find members of the National Association of the Remodeling Industry at [www.nari.org](http://www.nari.org).
- ▶ Check with your insurance company, licensed home inspector or building official for referrals.

### What should I look for or require from a contractor?

- ▶ Many, but not all, states require contractors to be licensed, bonded, registered and/or certified. Check with your local building permit office or consumer protection agency to find out local requirements. Verify by checking online or calling the authorizing agency.
- ▶ Lead-Safe Certified Renovators have an EPA photo certificate and are listed on the EPA website ([www.epa.gov/lead](http://www.epa.gov/lead)).
- ▶ Look at websites you trust that post contractor reviews for insights, but keep in mind that extreme comments may be unreliable. You can also check a contractor's online reputation by searching the company name with words like "scam," "rip-off" or "complaint."
- ▶ Check the Better Business Bureau ([www.bbb.org](http://www.bbb.org)) for records of complaints about local firms. Check with your state's attorney general's office or designated agency for complaints against contractors.
- ▶ Try to interview three or more contractors to compare and evaluate their suggested approaches, materials and expertise. If you can get multiple quotes, use the same scope of work and materials for each estimate.
- ▶ Ask each contractor to provide at least three references on similar jobs.
- ▶ Ask contractors for proof of current insurance (a Certificate of Insurance), showing liability, worker's compensation and property damage coverage.
- ▶ Once you select a contractor, get a written contract that clearly states:
  - The contractor's obligation to get all required permits, and to maintain insurance
  - A detailed scope of work, list of materials, plan for protection during work, and who is responsible for site clean-up and debris disposal
  - The estimated start and completion dates
  - Total cost and schedule of payments (Limit your down payment, and tie payments to completion of defined stages of work.)
  - A requirement for copies of vendor receipts or a lien waiver (to prevent vendors the contractor has not paid from seeking payment from you, after you've already paid the contractor)
  - An agreement to withhold final payment until completion and satisfactory inspection
  - Warranties covering workmanship and materials.
- ▶ Following completion of regulatory work or decontamination jobs (such as mold, lead or asbestos remediation), get a clearance certificate or report.

### What should I avoid when hiring a contractor?

- ▶ Avoid door-to-door solicitors who offer restoration work. They are especially common after disasters.
- ▶ Avoid contractors who push for a quick decision, making it impossible for you to get competitive bids, check licenses, and review references.

- ▶ Do not hire unlicensed or uninsured contractors. Do not hire contractors who claim to be operating under another firm's license or certification, or whose license is from a different state. Check the date of a contractor's license to make sure it has not expired.
- ▶ Get a written agreement, not just a verbal agreement. Do not sign an agreement or anything else until you have read and clearly understand all the terms.
- ▶ Find out about local laws or regulations on contracting for home repairs. Some states have a "right of rescission," often known as a buyer's remorse rule, that allows a set period of time (usually 3 days) in which you can cancel a contract you signed in your home.
- ▶ It's best to avoid making up-front payments to a contractor before work begins. If down payments are customary in your area, don't pay more than 10% or \$1,000, whichever is less, of the total cost before work begins. Do not let the payment schedule get ahead of work completed. Do not pay for materials without copies of receipts or a lien waiver.
- ▶ Do not make the final payment until you are satisfied with the job.
- ▶ Never pay cash. Keep a record of all payments.
- ▶ Do not hire contractors who recommend fogging or spraying as the method to clean up mold.

## Prepare the Work Site

### How should I prepare the work site?

A well-prepared work site will help you and other workers be productive and stay safe. This includes: protecting a damaged home with temporary weather barriers, providing for basic needs of workers, taking some key precautions, setting up a clean-up station, and installing containment barriers to isolate the work area from clean areas.

### INSTALL TEMPORARY WEATHER BARRIERS

If the roof, exterior walls, windows or doors are damaged or missing, cover with temporary weather barriers as soon as possible to prevent further damage from water entry.

**CAUTION!** Falls from roofs and ladders are causes of common post-disaster injuries. Try to arrange for a professional installation (or FEMA assistance, if you're eligible). If you must do it yourself, don't work alone. Wear a helmet. Check for slippery and weak roof conditions. Use a safety harness or other methods to work safely on steep slopes.



**PHOTO:** FEMA-provided "blue tarp" temporary roof protection.



**Roof:** Protect a damaged roof with a heavy tarp, securely attached with wood strips nailed into framing.

If roof damage is minimal, consider making immediate repairs. You may be able to replace missing shingles and use roofing cement or patch products to seal down loose shingles and flashing.

**Windows:** Cover the exterior of broken windows with heavy (6 mil) clear plastic sheeting to block rain, yet admit light. Fold over, tape and secure the edges with wood strips to withstand wind.

**Exterior Walls:** If any siding, brick veneer or other cladding is missing, cover the damaged section of wall with tear-resistant housewrap (weather barrier). Wrap it across the damaged wall in layers from the bottom to the top of the wall so the layers overlap shingle-fashion. Secure the housewrap with cap nails and seal seams and edges with a compatible construction tape or cover with plywood.

### PROVIDE BASICS

Provide nearby access to:

- ▶ Water supply for washing (not contaminated)
- ▶ A toilet
- ▶ If possible, a place to shower off, especially if there is heavy mold contamination
- ▶ Ample drinking water (bottled water or cooler with disposable cups)
- ▶ A clean, comfortable place to take breaks away from the work area
- ▶ A safe source of power for tools, lights and equipment (GFCI electric outlet, a solar generator, or a gasoline generator placed outside because of the carbon monoxide emissions and fire hazards it can create, plus heavy-duty outdoor extension cords)
- ▶ Work lights, preferably break-resistant types. A well-lit work site is a safer work site.

### TAKE PRECAUTIONS

- ▶ Enforce no smoking, eating or drinking within work areas or near debris. Don't allow children in work areas.
- ▶ Provide two UL-rated 10ABC fire extinguishers in handy locations.
- ▶ Pull out or bend over protruding nails. Safely remove broken glass and other sharp hazards.
- ▶ Provide for stable entry and exit paths. Lay plywood on muddy and slippery areas.
- ▶ If there is major damage to floors such that they might not be structurally sound, set up a plywood pathway throughout the house. Cut the panels into 2-foot by 8-foot sheets to assemble the walkways.

## ... HEAT/COLD PRECAUTIONS ...

### Avoid heat stress

Working in hot, humid conditions can quickly cause heat stress. To avoid heat exhaustion:

- ▶ Drink lots of water, even when not thirsty.
- ▶ Avoid alcoholic beverages and limit caffeine, since they further dehydrate you.
- ▶ Take breaks often, and rest in a cooler, shady spot.
- ▶ Wear lightweight, light-colored, loose-fitting clothing made of cotton or other breathable fabric.
- ▶ Do the heaviest work at the coolest time of day.
- ▶ Minimize working in direct sun. Wear a wide brim hat and sunscreen.

### When it's cold...

- ▶ Dress in layers.
- ▶ Be aware of wind chill. Set up wind blocks, wear windbreaker clothing.
- ▶ Bring and drink warm fluids, but avoid alcohol or caffeine.
- ▶ Be aware of symptoms of hypothermia and frostbite: shivering, numbness, glassy stare, waxy skin.
- ▶ Never use unvented heaters indoors or gas ovens to heat a home. They can cause dangerous levels of carbon monoxide (CO) in a short time. Keep a battery-operated CO detector on hand.

### SET UP A CLEAN-UP STATION

#### Why do I need a clean-up station?

A clean-up station is the place to wash up before taking a break and before leaving the worksite. It's also the place to treat minor injuries, such as cuts and contact irritants. In hot weather, it is important for workers to take breaks every hour to avoid dehydration and heat stress.

#### Where should I locate a clean-up station?

It should be outside of the home, if possible. However, if it must be indoors, use a clean area of the house that is separated from the work areas.

#### What should be included in my clean-up station?

Each clean-up, health and safety station should include:

- ▶ A well-stocked first aid kit and extra spray antiseptic
- ▶ An eye wash station
- ▶ A list of emergency phone numbers
- ▶ Several clean-up buckets, a pump sprayer, and a supply of clean water
- ▶ Hand soap, detergent, and hand sanitizer
- ▶ Scrub brushes
- ▶ Paper towels
- ▶ Trash bin or bags.

ILLUSTRATION E  
Clean-up, Health and Safety Station

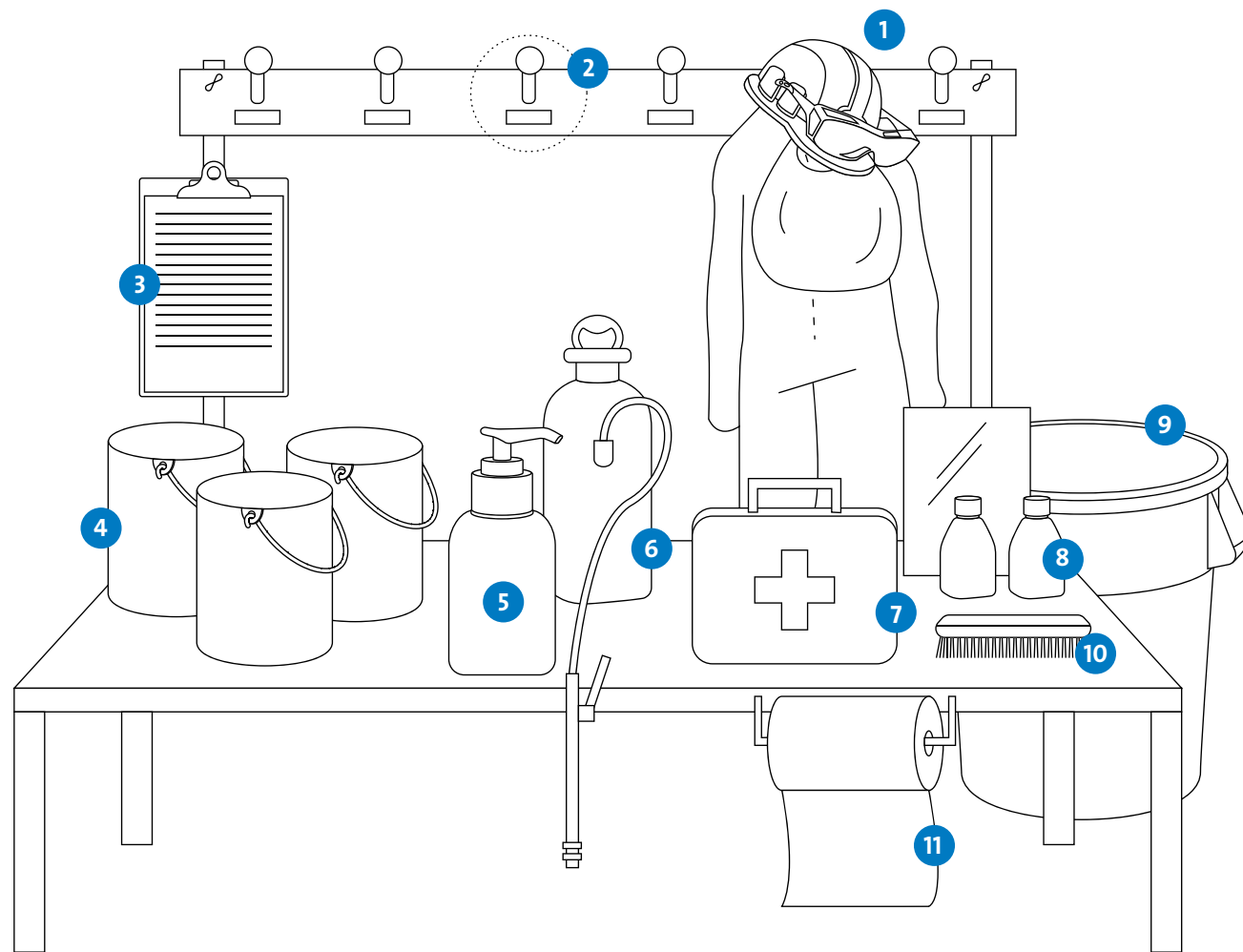

1. **Rack:** Place to hang work clothes, goggles, and respirator in clean plastic bag.
2. **Name tag:** Label each hook with worker's name.
3. **Clipboard:** Emergency phone numbers.

4. **When there is no running water:**
  - A. Rinse hands in first bucket.
  - B. Wash hands with soap and rinse in second bucket.
  - C. Final rinse with clean water from pump sprayer over third bucket.

5. **Soap**
6. **Pump sprayer of clean water**
7. **First aid kit with spray antiseptic**
8. **Eye wash station**
9. **Trash bin**
10. **Scrub brush**
11. **Paper towel dispenser**

**IMPORTANT!** Make sure you have a current tetanus shot (a booster is needed every 10 years). If you have not been vaccinated or are unsure, contact your health care provider or local public health clinic.

**SET UP CONTAINMENT**

**What is containment and why do I need it?**

Containment refers to sealing off work areas to isolate them from other areas. It's important to keep clean areas separate from the work areas to minimize the risk of spreading contaminants.

**Where should I set up a containment area?**

Set up barriers, such as plastic sheeting, in doorways, over vents and other openings to create a containment area between the current work area and all adjacent clean areas. If possible, the containment area should have a window or other opening to the outdoors.

**How should I set up a containment area?**

Seal off air vents and any other openings into clean rooms with plastic sheeting or other disposable material and tape. Follow these steps to cover the doorways of a containment area.

- ▶ Use **6 mil plastic sheeting** to cover doorways. Cut a piece a few inches larger than the door. Create a few pleats at the top and bottom to leave slack; tape the sheet to the doorframe with masking tape, but not taut. Reinforce the top with duct tape and a staple gun or with furring strips nailed so as to avoid damaging molding. The bottom of the sheet should be taped to the floor with corners stapled to the bottom of the doorframe or the floor.
- ▶ Cut a **vertical slit in the center** of the plastic sheeting, leaving about 6 inches uncut at the top and bottom. Reinforce the ends of the cut with duct tape. This will allow passage through the slit.
- ▶ **Cut a second sheet** of plastic as wide as the opening, and tape it to the top of the door **on the clean room side**. Let it hang and trim the bottom so it is a couple of inches from the floor.
- ▶ Create a **negative air pressure zone** in the work area (pulling work area air to the outdoors). One way to do this is to place a box fan in a window opening aimed to **blow to the outside**, and seal around the fan. This will draw dirty work area air outdoors and create suction on the door flaps to keep them pressed against the cut opening.

**Clean-Out and Tear-Out**

**How should I clean out a damaged home?**

Depending on the types and level of damage, the full process may need to be done in phases. The first task is to clean-out by removing contents and residue of the disaster, such as mud, water or ash. The next phase is removal of damaged materials, if needed. This can involve gutting and tear-out (demolition). Both phases should be completed before cleaning and decontamination efforts.

ILLUSTRATION F  
Creating a Containment Area Plastic Sheet Flap Seal

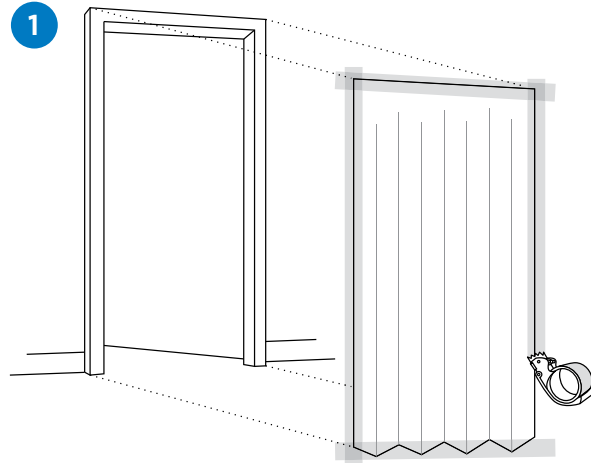

**1**  
Cut 6 mil plastic sheeting larger than door.  
Pleat for slack and attach to door frame.  
Reinforce top and corners.



**2**  
Cut vertical slit for passage. Tape ends of slit.

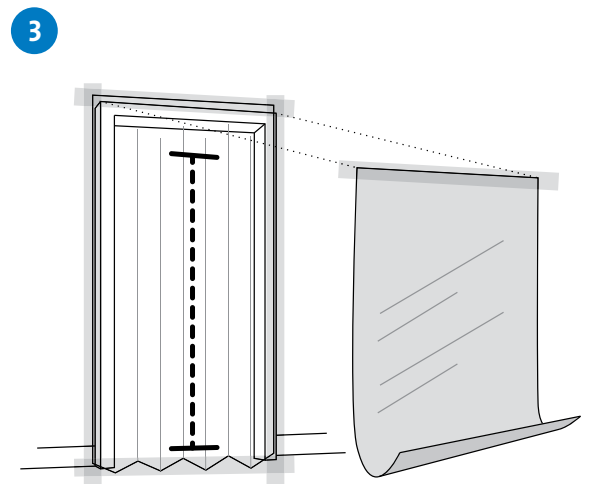

**3**  
Hang second flap on clean room side.

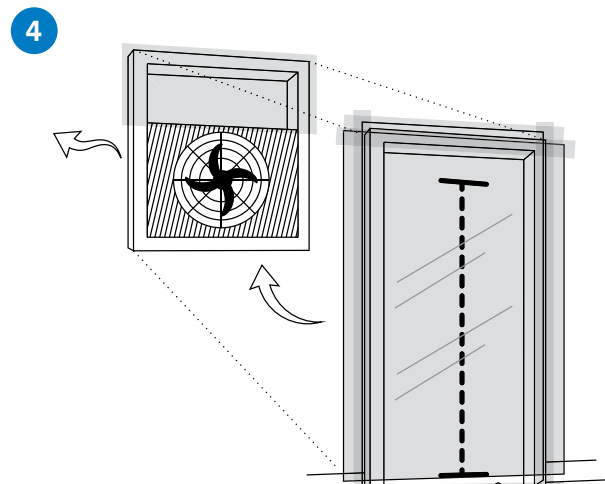

**4**  
Blow air to outdoors – to exhaust dirty air and keep flap pulled closed.  
Enter closed area by lifting flap and stepping through slit.

Protect Yourself...  
First and Foremost

Assess Damages  
and Hazards

Create a  
Work Plan

Prepare the  
Work Site

Clean-Out  
and Tear-Out

Clean and  
Decontaminate

Restore for  
More than Before

REMOVING CONTENTS

**What should I do first to clean out the home?**

After it is safe to enter the damaged building, wear personal protective equipment (PPE) and open doors and windows to air it out for 30 minutes before you start work.

**IMPORTANT!** Select and wear PPE that is appropriate to protect you from all the possible hazards in the home and the work activities you tackle (see PPE and *Assess Health Hazards* sections).

**If the home was flooded:**

- ▶ Keep electricity turned off and use a gasoline or solar powered pump to remove water. If using a gasoline pump, keep it outside the house.
- ▶ If there is more than six inches of water in a basement or crawl space, pump it out slowly. More damage could be caused by unequal pressures, causing walls to cave in or floors to push up. Pump out a third of the water per day for three days. Discharge it far away from the building.
- ▶ If the home contains mud and silt, shovel it out before it dries and hardens.
- ▶ When possible, dry building materials and contents quickly (within three days) to prevent mold growth. Materials dry faster when relative humidity is low. If it's safe to do so, run a heater or air conditioner, plus a dehumidifier and fans, to speed the drying process. (Note: If mold is already present, do not use fans or central air since that could spread mold spores to clean areas.)

**For fire and smoke:**

- ▶ There may be a large amount of ash to remove. Note that it can be an irritant or be contaminated, so wear an N95 or higher respirator.
- ▶ Very gently push the ash with a broom into bags or boxes for disposal. Avoid vigorous sweeping to minimize ash in the air. Follow with damp mopping, then a HEPA vacuum, if available.
- ▶ Don't wash ash or soot into storm drains.

**For all damaged homes:**

- ▶ Do not attempt to remove objects that might cause debris piles or the structure to shift or fall. If collapse could happen, seek professional help or equipment.
- ▶ Open or remove window treatments to allow maximum light and ventilation.
- ▶ Carefully remove hazardous waste including chemicals, pesticides, fuels, damaged batteries, paints, damaged fluorescent lights, etc. Do not handle leaking containers of hazardous material; contact your local waste management or emergency management office.
- ▶ Carry materials the shortest possible distance to their storage or disposal location to reduce cross-contamination.

**Helpful Hint:**

Avoid skin contact with sediment, which may contain toxic chemicals and bacteria.





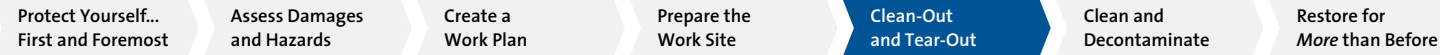

## Furniture

### What furniture should I remove?

Remove all wet, moldy and damaged furniture from the building. Pieces that can be salvaged are best cleaned outdoors and repaired before being returned inside the home.

### How should I remove the furniture?

Use dollies or wheelbarrows to remove damaged or wet furniture since it may be weakened. Flooded pieces made of pressboard or particleboard could collapse when moved. If possible, take them apart before moving them.

### What furniture can I save?

- ▶ Solid wood case goods, metal, plastic and some plywood furniture and cabinets that are in sound condition may be cleaned and restored outdoors or off-site. Take wet furniture outside and remove all removable parts, such as drawers. If muddy, hose off then place in a protected area out of direct sunlight to dry slowly until it can be restored.
- ▶ Discard upholstered furniture and mattresses that were contaminated by floodwater, fire, smoke, toxic chemicals or settled asbestos fibers. Valuable pieces you want to try to salvage must have the foam and upholstery replaced.
- ▶ Valuable upholstered pieces that have been wet less than two days from clean rain water or plumbing leaks may be dryable with professional water extraction and drying equipment.

## Appliances and Fixtures

### What appliances and fixtures should I remove?

Damaged appliances, those with water trapped in insulation or inaccessible cavities, and any equipment and electrical fixtures exposed to salt water should be removed for proper disposal.

### How should I remove the appliances and fixtures?

- ▶ Do not move large appliances on light duty handcarts, because they can easily tip over. Tie appliances onto a dolly.
- ▶ Tape or tie flooded refrigerators shut before moving them, to avoid spilling spoiled food, and to prevent child entrapment.

### What appliances and fixtures should I save?

- ▶ Unbroken plumbing fixtures such as sinks, toilets, and bathtubs can be cleaned in place.
- ▶ Some appliances that got wet or exposed to residue may be salvageable, such as laundry equipment, dishwashers with replaceable insulation, and microwave ovens. However, they should be inspected and serviced by a professional before use.

### Helpful Hint:

Watch out for exposed nails and splintered edges.

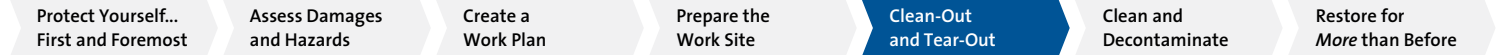

- ▶ Undamaged, cleanable lighting fixtures and ceiling fans may be inspected and saved if they have not been exposed to salt water.

- ▶ Appliances with floodwater, ash or other contaminants trapped inside should be discarded.

## Carpeting and Rugs

### What carpeting should be removed?

- ▶ Remove all wet or contaminated carpeting, rugs and padding.
- ▶ Discard all wet padding. Discard flooded wall-to-wall carpeting (see exception below).
- ▶ All carpeting, rugs and other absorbent floor coverings contaminated with lead dust, asbestos or toxic chemicals should be sealed in heavy-duty plastic wrap, labeled and discarded as hazardous waste. (See *Assess Health Hazards* and *Disposal* sections.)
- ▶ Dry but damaged carpeting can remain on the floor as a “tarp” to catch debris and protect the subfloor when you remove building materials from the walls and ceilings.

### How should I remove the carpeting?

Cut carpet into strips a few feet wide, roll them up, and take outside. Rolling wet carpet rolls onto an old blanket or tarp can make them easier to drag.

### What carpeting can I save?

Valuable rugs that got wet or dirty (and are free of lead dust, asbestos or toxic chemicals) can be hosed off, draped to dry outdoors, and brought to a rug cleaner for disinfection, cleaning and drying. Washable rugs can be laundered with color-safe bleach, dried and stored until work is complete. If you want to salvage valuable rugs that are contaminated with lead, asbestos or chemicals, seal them in 6 mil plastic sheeting for pick-up by a hazardous materials firm for cleaning off-site.

Wall-to-wall carpeting that was wet with only **clean or gray water** and does not have heavy mold may be cleaned with sanitizing carpet cleaner, dried and reinstalled by a professional. However, wet carpet padding should always be discarded and replaced. Wall-to-wall carpeting flooded by contaminated **black water** should be discarded.

## CLEAN, GRAY AND BLACK WATER

Clean-up procedures and what you can salvage from water damage depends on the type of water. **Clean water** includes rainwater, leaks from broken water supply lines, and tub or sink overflows with no contaminants. **Gray water** or unsanitary water may include leaks from dishwashers or washing machines, punctured waterbeds or broken aquariums. **Black water** contains disease-causing (pathogenic) agents and is extremely unsanitary; it includes flooding from seawater, rivers or other rising stormwater. **Gray water** that remains untreated for longer than 48 hours can change to the **black water** category as microorganisms multiply.

## Small Objects

### What small objects should I remove?

- ▶ Remove all items that will be either discarded or cleaned. Sort into separate bags and areas.
- ▶ Discard porous items exposed to floodwater or other contaminants that cannot be safely laundered and decontaminated. Examples of materials to discard include cosmetics, food (other than intact canned goods), stuffed toys and throw pillows, non-valuable paper products, particleboard shelves, etc.
- ▶ Dispose of electronic and electrical items exposed to salt water or other corrosives.

### How should I remove the small objects?

Place all small items in heavy-duty trash bags to minimize the release and spread of contaminated residue or mold on them. Electronics and hazardous waste (batteries, contaminated items, etc.) should be bagged with similar waste, labeled and disposed according to local waste handling guidelines.

### What small objects should I save?

- ▶ In general, undamaged non-porous items can be cleaned and saved. This applies to items made of china, glass, porcelain, metal, hard stone, and hard plastics that don't have trapped water inside. Any items exposed to floodwater or sewage will need to be disinfected with a product that is safe for the material.
- ▶ Solid wood items are cleanable and may be restorable if not warped, split or damaged.
- ▶ Fabrics not exposed to asbestos or toxic chemicals can be laundered or dry cleaned. Fabrics contaminated by asbestos or toxic chemicals should be disposed of as hazardous waste.
- ▶ Valuable art, photos, books and legal documents with limited water, mold or soot damage may be restorable by professional restoration services. In the meantime, they should be removed and spread out where they can dry away from direct sunlight. Contact a restorer for additional guidance.

## GUTTING AND TEAR-OUT (DEMOLITION)

After contents are removed, it's time to remove damaged building materials that will not be restored. This is known as the demolition phase. It may range from only minimal tear-out of isolated damage to complete gutting of walls and/or ceilings and floorings to remove wet insulation, subflooring or other damage.



**PHOTO:** Bag small items for disposal to reduce spread of mold and other contaminants.

## Cabinets, Shelves, Doors, and Trims

### Should I remove cabinets, shelves, doors, and trims?

- ▶ Built-ins, like kitchen cabinets and entertainment centers, should be removed if the attached walls were structurally damaged, or were flooded and contain insulation. Flooded walls with insulation will need to be opened to repair or remove insulation and allow cleaning and drying of wall cavities.
- ▶ Water-damaged built-ins and trim made of particleboard or other water-sensitive materials should be removed and discarded, since they are likely weakened. Solid lumber and plywood tend to retain strength and may be saved (but may need to be cleaned and slowly dried).
- ▶ Remove doors and trim that are swollen from being wet, if not needed for security. If you need to keep them in place, keep them closed and facilitate slow drying in place.
- ▶ Metal and fiberglass-skin insulated doors and sliding doors that are undamaged and operate properly may be left and cleaned in place. Inspect for wood edges that might be damaged, and corrosion of metal from exposure to salt water or chemicals.
- ▶ Carefully remove and try to save antique and historic home materials since they may remain valuable and usually are constructed with high quality woods and joinery better able than modern materials to withstand damage. Consider consulting professional restoration services.

### How should I remove cabinets, shelves, doors, and trims?

- ▶ Remove doors from hinges. Doors to be restored should be laid flat on pallets where they can dry slowly out of direct sunlight to minimize warping. Solid wood will shrink as it dries, and may be restorable if not too warped or split.
- ▶ Damaged doors and flooded hollow interior doors should be discarded.
- ▶ Remove trim you hope to salvage by prying gently with a crowbar. Remove protruding nails for safety and lay trim flat where it can dry out of direct sun. If discarding trim, bend protruding nails during removal to prevent future puncture wounds.
- ▶ Tape cabinet doors closed, then work in teams to detach and move large and heavy built-ins. If wet, remove shelves and open doors to dry before removal.

### ... IMPORTANT!

During gutting and tear-out activities, give special attention to guidelines for avoiding exposure to and the spread of lead paint dust, asbestos, mold, fibrous insulation, and ash. See *Assess Health Hazards* section.

Do NOT remove structural, load-bearing parts of any walls, floors, or roofs without technical assistance from a qualified professional.

### Helpful Hint:

Use multiple layers of disposable tarp taped to the floor to catch debris from interior gutting. As needed, the top layer can be rolled or folded and sealed for removal and disposal of the debris.

... CAUTION! ...

**If a ceiling or wall is moldy, insulated, or may have lead-based paint**, set up containment and wear personal protective equipment (PPE) before doing any gutting work. (See Containment guidelines in *Prepare the Work Site* and *Protect Yourself* sections.)

It's helpful to cover sections of ceiling or wall material with thin plastic sheeting before removal to prevent a massive release of mold spores or lead dust into the air. (Refer to mold and lead precautions and resources in *Assess Health Hazards* section.) Do NOT tear out surfaces that may contain asbestos. Consult an asbestos professional to assess the situation and determine the safest solution.

**If gutting reveals insulated pipes** (especially hot water pipes) in homes built before 1980, the insulation might contain asbestos. Refer to asbestos precautions and resources in *Assess Health Hazards* section.

## Ceilings

### Should I remove ceilings?

- ▶ If the ceiling is bulged, dripping water, crumbling, or has heavy mold growth, those segments should usually be replaced. However, if it might contain asbestos, do not automatically remove it. A “popcorn” ceiling treatment or ceiling tiles in some homes built before 1980 could contain asbestos. Consult an asbestos professional to assess the situation and determine the safest solution.
- ▶ If the ceiling appears undamaged, is free of saturated insulation, and does not have substantial or long-term mold growth on either side of the ceiling, it may be left in place and restored.

### How should I remove drywall, plaster or ceiling tiles from ceilings?

- ▶ Be alert to the potential for collapse from heavy, wet insulation or structural damage.
- ▶ Disconnect and remove light fixtures, ceiling fans, speakers, smoke detectors, etc., from the ceiling before removing ceiling material.
- ▶ If possible, set up a plywood platform in the attic and work from above the ceiling. Cut out the damaged area and allow it to drop to the tarp on the floor.
- ▶ If you must work from below the ceiling, use a ladder tall enough to allow you to get your head above the ceiling (once some ceiling is removed) with your hips no higher than the top of the ladder. This prevents the ceiling from coming down on top of you. Use a long saw to cut out a section and a crowbar to push it down. Try to keep your head above the ceiling surface.

## Walls

### Should I remove interior wall materials?

Dry interior wall materials (typically drywall, plaster on older homes, or paneling) can normally be cleaned and patched.

If there was flooding, water leaks, heavy mold growth, or structural damage to walls, partial or full removal is recommended.

- ▶ **Insulated walls:** Insulation inside walls that flooded must be removed, since it holds water and can lead to hidden mold, decay and insect infestation. The interior wall finish should be removed to the “wicking line” (where water soaked above the flood level) or higher. Remove all wet and moldy insulation. (Exception: Non-porous types of insulation, such as closed cell foam, do not absorb water so may be kept in place.)
- ▶ **Drywall:** Standard gypsum drywall has paper facings, a food source for mold. If there is heavy or long-term mold growth that penetrates the paper facing, or the drywall has lost strength, it should be replaced. If there is no insulation in the wall, and little or no mold growth, it may be reasonable to clean and speed-dry it to avoid replacement. (Note: There remains risk of hidden mold in the wall cavity, so this is not advised where occupants are especially sensitive to mold.)
- ▶ **Plaster:** Plaster is more water-resistant than drywall and does not contain paper. It also may have historical value in old homes. Many old homes have no insulation, so it can be feasible to clean and dry the plaster, since empty wall cavities typically dry quickly. Consult renovation resources for methods to patch and restore damaged old plaster.
- ▶ **Paneling:** Paneling should be removed, since it can usually be cleaned, dried and reinstalled after the wall cavities have been cleaned and dried.
- ▶ **Wallpaper:** Wallpaper, especially vinyl wallpaper, should always be removed from any wall that got wet. Vinyl wallpaper should not be replaced since it hampers drying and can cause hidden moisture problems in air conditioned homes.

### How should I remove interior wall material?

Remove items mounted to walls and the face plates of switches and outlets before removing wall finishes.

### Trim and Paneling

- ▶ To remove without causing damage, gently pry loose any molding, window trim and paneling using a crowbar or hammer claws.
- ▶ Remove protruding nails and screws if the material will be saved. Bend them over if it will be discarded.

### Drywall

- ▶ Mark a line and cut drywall at a panel seam (normally at 4-foot intervals) above the flood wicking line. This simplifies installation of new panels with less trimming and waste, since they tend to be 4-foot by 8-foot sheets. Cut the drywall with a drywall saw or reciprocating saw (trim the blade so its depth equals drywall thickness to avoid cutting studs, wiring, etc.).
- ▶ Remove drywall in large pieces to minimize dust and place in sturdy garbage bags for disposal.
- ▶ Remove nails and screws from the studs.

### Plaster

- ▶ Cut through the plaster and lath between studs with a reciprocating saw. (**CAUTION!** Joint compound in old plaster walls and ceilings may contain asbestos. Refer to asbestos precautions in the *Assess Health Hazards* section.)
- ▶ Use a pry bar to pull plaster and lath away from the studs. Bundle the lath separately and discard. Shovel plaster piles into large cans or heavy-duty bags for disposal.

### Floors

#### Should I remove flooring?

- ▶ Do NOT remove identified or suspected vinyl asbestos tile, even if damaged. See asbestos repair in *Assess Health Hazards* section.
- ▶ Remove burned or damaged non-asbestos flooring.

For flooded homes:

- ▶ Remove flooded floor coverings that contain paper or composite wood backings (most sheet vinyl, laminate and engineered wood floorings), or that has separated from the subfloor or slab.
- ▶ Flood-resistant floorings that may be able to stay in place include ceramic/porcelain tile; solid vinyl tile, inlaid sheet vinyl and linoleum with no paper backing; brick/stone/terrazzo/concrete; and solid wood plank flooring.
- ▶ Any type of flooring installed on water-sensitive subflooring, such as oriented strand board (OSB) panels, may need to be removed to replace water-damaged subflooring. Solid wood and plywood subflooring can often withstand flooding, but may swell when wet and cause temporary buckling.
- ▶ Solid wood planks swell when wet, but can be saved if they can dry out in both directions. Polyurethane finishes impede top-side drying. Carefully remove a plank every few feet to reduce buckling caused by the swelling. If planks are tongue-and-groove, consult a flooring professional.
- ▶ Allow wood subflooring or concrete slab to dry thoroughly before installing new flooring. Blowing air beneath the wood, when possible, can speed the drying process. Use a pin-type wood moisture meter to check moisture level periodically until the reading remains stable and the subfloor wood is at equilibrium (8 to 15%, depending on your area's climate). Wood moisture meters are available from some hardware stores, home improvement stores, tool suppliers and online vendors.

### Insulation

#### Should I remove insulation?

- ▶ All wet and moldy fibrous and open cell foam insulation must be removed and discarded. NEVER leave wet insulation in place, even if it is wet with clean water and the interior wallboard appears dry. It will hold water and cause long-term problems. Wet fibrous insulation also loses its insulating value.

- ▶ Closed-cell rigid foam board or spray foam (2 lb. density) insulations are not absorbent, and can remain in place if they do not prevent drying of other materials and have no damage.
- ▶ Remove all fire-damaged insulation. Where walls are opened in a smoke-damaged home, replace insulation that absorbed smoke odor.

#### How should I remove insulation?

**CAUTION!** Fiberglass and mineral insulation fibers can become airborne. Wear full personal protective equipment and avoid activities that create and spread mineral or glass fibers.

- ▶ Cut batts and open cell spray foam above the flood level with a utility knife and remove sections that became wet even if no longer wet at the top. Water migrates downward, but contaminants can be retained and insulating value is reduced after wetting.
- ▶ For loose-fill and dense-pack insulation, install a temporary dam material to hold the dry insulation in place. Scoop out any wet, matted and moldy insulation.
- ▶ Remove insulation directly into heavy duty trash bags for disposal.

### Exterior Claddings

#### Should exterior cladding materials be removed?

- ▶ Most exterior wall claddings (siding, brick veneer, etc.) that appear undamaged can remain in place. Remain alert to signs of water leakage into wall framing, especially at windows, interior corners and overhangs. Claddings without a drainable gap behind them, such as some stucco systems, are more prone to moisture problems.
- ▶ When reroofing, existing roofing material should be removed before installing new material.
- ▶ Exception: Do NOT remove damaged asbestos cement siding or roofing, unless it is done by a qualified asbestos professional. It's usually best to cover it with new siding. See asbestos procedures in *Assess Health Hazards* section.



**PHOTO:** Remove all wet or fire-damaged insulation, even if wallboard appears to have dried.

- Protect Yourself...  
First and Foremost
- Assess Damages  
and Hazards
- Create a  
Work Plan
- Prepare the  
Work Site
- Clean-Out  
and Tear-Out
- Clean and  
Decontaminate
- Restore for  
More than Before

## Clean and Decontaminate

### MOLD

#### What should we do to safely remove mold and keep it from returning?

When you're unable to hire a trained professional to remove mold in your water-damaged home, use these 10 steps for do-it-yourselfers (DIY) to tackle the job as safely and effectively as possible. Copy the *10 Steps* fact sheet ([pages 51 to 52](#)) on both sides of a single sheet of paper and give one to each worker to read and follow.

### SURFACE CLEANING AND TREATMENT

#### How should I prepare surfaces for cleaning?

- ▶ If walls or ceilings were gutted, remove all remaining protruding nails and/or screws, any residual insulation and pieces of drywall or plaster from framing.
- ▶ If silt from flooding remains, hose it out unless the water would rewet vulnerable materials. If so, remove the silt with a shop vacuum or sweep into a bag-lined container for disposal.

#### How should I clean interior surfaces and wall cavities?

For flooded or moldy surfaces:

- ▶ Clean with a non-phosphate detergent solution, since any remaining phosphate residue provides food for mold.
- ▶ Damp-wipe cleanable surfaces to remove soil and mold first, before disinfecting. Disinfectants are less effective on dirty surfaces. Try to avoid saturating materials that have dried.
- ▶ Disinfect flood- and sewage-contaminated surfaces with a product suitable to the material.
  - CAUTION!** Disinfectants are hazardous products. Read and follow label instructions.
    - A V-cup concentrated chlorine bleach to a gallon of water is an inexpensive disinfectant usable on non-metal and colorfast surfaces. It may be lightly sprayed inside wall cavities. Weaker solutions may be used as a sanitizer.
    - Other less corrosive disinfectants, such as alcohols, hydrogen peroxide and quaternary ammonium, are readily available alternatives.
- ▶ Once dry, vacuum surfaces with a HEPA vacuum cleaner, including electric outlet boxes and open ducts. A back-pack vacuum is ideal for working from ladders. Use a corner tool to reach tight spaces.
- ▶ An alternative method for removing mold from wall cavities and wood framing without rewetting is professional soda blasting. Other alternative products include commercial fungicidal coatings that can kill mold, and fungistat or mildewstat coatings that inhibit mold growth.

...  
WARNING

Never mix chlorine bleach with ammonia or acids. Do not use in the heating and air system, since it is corrosive. Do not use chlorine bleach on fine wood furnishings since it can raise the grain.

# 10 Steps

## for Safe and Effective DIY Mold Removal

### 1. Wear Protective Gear

People are exposed to mold by breathing spores and by skin contact. Wear gloves, goggles and a NIOSH-approved respirator rated N95 or higher. Some respirators have valves to make it easier to breathe. A properly fitted half-face N100 respirator with filter cartridges provides greater protection and comfort than the mask types.

### 2. Isolate Work Area and Ventilate to Outdoors

Disturbing mold colonies during clean-up can cause a huge release of spores into the air, so seal off the moldy areas from the rest of the house. Open windows, and don't run the central heating or air conditioning system during clean-up. Tape plastic over air grilles, and drape plastic in stairwells if other levels are dry and clean. If you have power, put a box fan in a window to blow out and exhaust mold-filled air to the outdoors.

### 3. Remove Moldy Porous Materials

Porous moldy or sewage-contaminated materials should be removed, put in plastic bags and discarded. To reduce the release and spread of mold spores, it is helpful to cover moldy material with plastic sheeting before disturbing it.

- Remove all flooded carpeting, upholstery, fabrics and mattresses right away. It's best to discard them, but if you hope to salvage a valuable rug or furniture, have it professionally cleaned, disinfected and dried. Tell the cleaner about the mold and its cause. Never reuse flooded padding.

- Remove all wet fibrous and open cell foam insulation – even if wallboard appears to be dry. Wet insulation will stay wet far too long, leading to the growth of hidden mold and wood decay inside the walls. Cut wall covering above the level that was wet; water can wick up above the flood level.
- It's best to remove all moldy, porous materials (except solid wood), especially if there is heavy or long-term mold growth, such as paper-faced drywall and flooring, processed wood products, ceiling tiles and paper products.
- Plaster and non-paper faced drywall walls that have dried, are in good condition **and have no insulation** in the wall may be cleaned and sanitized to salvage them. However, there is a risk of mold on the backside that can release spores into the indoor air. If you choose to restore these materials, try to seal all interior gaps to be airtight before repainting.
- Remove all vinyl wallpaper and any other materials that hamper drying. Interior-side vapor barriers or foil-faced insulation should be removed.

### 4. Clean and Disinfect

Surface mold can be cleaned from non-porous materials such as china, hard plastic, glass and metal; solid wood can also be cleaned since mold grows only on its surface. **Cleaning should remove mold, not just kill it, because dead spores can still cause health problems.**

**If there was flooding or sewage contamination, disinfection is a must.** Follow label directions and warnings, handle carefully, wear rubber gloves, and never mix bleach with ammonia or acids. Many disinfectants, including bleach, can kill molds, but **do not prevent regrowth of new colonies when materials stay damp.**

- Remove any sediment. Hose out opened wall cavities, if necessary.
- Wash dirty or moldy materials with non-phosphate, all-purpose cleaners, because phosphate residue is mold food. Rough surfaces may need to be scrubbed. Rinse, but avoid high-pressure spray.
- If available, use a HEPA-filtered vacuum (not a regular vacuum) to remove dust and mold residue.
- Disinfect wall cavities and other materials **after** cleaning. Soil can make some disinfectants, including bleach, less effective. On colorfast, non-metal surfaces, a solution of V-cup concentrated chlorine laundry bleach per gallon of water can disinfect. Do not use bleach in the air conditioning system. Milder, less corrosive disinfectants include alcohols, quaternary ammoniums and hydrogen peroxide.

#### 5. Consider Borate Treatment

Applying a borate treatment to wood framing provides resistance to termites and decay, and may inhibit mold growth. The type that penetrates the wood over time offers greatest protection. Do NOT apply sealants that can hamper drying.

#### 6. Ventilate

After cleaning and disinfecting, air out the building. Use fans in windows to pull mold spores to the outdoors.

#### 7. Speed Dry

Dry all wet materials as quickly as possible. Close windows and if possible run the air conditioning or heat and use a dehumidifier. If there is no power, keep windows open.

#### 8. Remain on Mold Alert

Continue looking for signs of dampness and new mold growth. Mold can form in as little as 2 to 3 days if materials stay damp. Wood and other materials that may look dry can still be wet enough to support new growth. If mold returns, repeat cleaning and use speed drying equipment and moisture meters. Regrowth may signal that the materials aren't dry enough or should be removed.

#### 9. Do Not Restore until All Materials Have Dried Completely

Wood moisture content should be **less than** 16% (get a wood moisture meter). Do NOT use vinyl wallpaper, oil-based paint or other finishes that block drying to the inside.

#### 10. Restore with Flood-Resistant Materials

If possible, restore with materials that can withstand a flood with less damage. Use closed-cell foam insulation that does not absorb water and solid wood or water-resistant structural materials. Elevate wiring and equipment. Consider removable wainscoting or paperless drywall, and water-tolerant flooring such as ceramic tile, solid wood, stained concrete, etc. Some new wallboard materials may be more mold-resistant.



Protect Yourself...  
First and Foremost

Assess Damages  
and Hazards

Create a  
Work Plan

Prepare the  
Work Site

Clean-Out  
and Tear-Out

Clean and  
Decontaminate

Restore for  
More than Before

#### **For surfaces with lead-based paint:**

- ▶ Review lead-safe work practices guidelines (in *Assess Health Hazards* section and at [www.epa.gov/lead](http://www.epa.gov/lead)). Remove any loose or eroded paint with lead-safe methods before cleaning – either by wet scraping or with a HEPA vacuum attachment.
- ▶ Damp-wipe with household cleaning products. Do not sweep or use a non-HEPA vacuum cleaner.
- ▶ Wrap lead debris in plastic bags or sheeting and seal tight for disposal.

#### **For fire and smoke damage:**

Soot can be oily and easily stain textiles and porous materials. If possible, hire a professional fire damage restoration professional. If that isn't feasible, try these methods:

- ▶ To clean soot from smooth surfaces, skim items with the suction-only nozzle (no beater brush) of a vacuum cleaner with a HEPA (high efficiency particulate air) filter to let suction pull off the soot.
- ▶ To clean dry soil and soot in carpeting, use a HEPA vacuum with a beater brush.
- ▶ Safely use a dry chemical sponge (sold by cleaning supply companies), rubbing alcohol, or other non-water based cleaner to wipe light soot from drywall, bare wood and other porous surfaces.
- ▶ For light, dry soot on plaster walls, avoid a water-based cleaner since it can cause stains to bleed into the wall. When there is heavy residue, wet soot, or plastic or rubber residue, plaster walls may need to be washed then sealed with a stain blocker before repainting.
- ▶ Use a household cleaning detergent in water for hard materials like tile, countertops, sealed wood, glass, metal and appliances.
- ▶ Clean plastics with a mild alkali detergent to remove and neutralize possible acidic soot. Acidic soot can be activated by humidity to cause permanent staining.
- ▶ Avoid scented deodorizers that only mask smoke odor and add chemicals to the air. Clean or replace materials, repeatedly launder fabrics, and ventilate to reduce odor. If odor lingers, try wiping with vinegar or baking soda, set out activated carbon or use odor absorbing products.

## Restore for More than Before

Can the work, time and expense that goes into repairing your damaged home have a silver lining? If you **restore for more than before**, you can be rewarded with a stronger, safer, more resilient, durable, comfortable, convenient and *healthy* home.

**Take control of your future!** Consider these home improvements in your restoration or rebuilding plan, and in future home renovation plans.

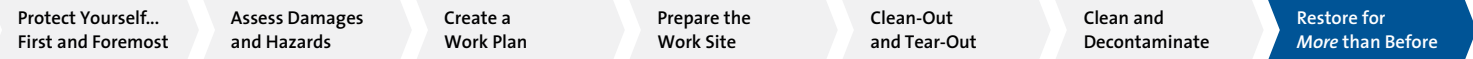

## RESILIENT HOME IMPROVEMENTS

Durable and resilient home improvements are your best defense against Mother Nature's destructive side. That includes not only disasters, but the toll that normal rain, sun, heat, cold, and insects take on your home and your wallet.

### Borate treatment of structural wood – for pest, decay and mold resistance.

Borate treatments are a safer, eco-friendly alternative to toxic pesticides and wood preservatives. They can provide long-term protection from decay and destructive insects, including termites, carpenter ants and powder post beetles. Some borate compounds can also deter mold growth while waiting for wood to dry after cleaning. Some products are formulated to treat mold.

Walls that have had to be opened present a golden opportunity to treat structural wood not normally accessible.

- ▶ Spray or brush a penetrating type of borate solution on the bottom two feet of open wall cavities, on subflooring and under floors. Try to get it into joints and gaps. It will not harm metals.
- ▶ In termite risk areas, treating the interior concrete foundation and basement walls (bottom two feet) can deter termite tunneling.
- ▶ Borate solutions can be applied to any bare, unfinished wood. Borate treatment is not suitable for wood in contact with soil or left unfinished outdoors, since water can leach out the borate.

### Flood-resistant features – so the next flood does far less damage.

Making your home resistant to flood damage means you can clean-up and move back in quickly, with minimal tear-out, replacement, cost and ordeal. It's not an all or nothing approach. Any of the following you can do will reduce future flood damage and the resulting health hazards.

#### Backflow Prevention

- ▶ Have a licensed plumber install sewage backflow valves in the drain line to protect your home and health. Even minor flash floods in the vicinity can cause sewage back-up.

#### Helpful Hints:

Explore [www.fema.gov](http://www.fema.gov), [www.disastersafety.org](http://www.disastersafety.org) and [www.flash.org](http://www.flash.org) for more detailed information about hazard-resistant home improvements, materials and construction methods. You can find out your termite, wind and seismic (earthquake) risk levels by checking with your local building official or looking up the risk maps in the International Residential Code (IRC) available online at [www.iccsafe.org](http://www.iccsafe.org). Your home's flood risk is shown on FEMA flood maps (available at [msc.fema.gov](http://msc.fema.gov)).



PHOTO: Install a plumbing backflow valve to prevent sewage back-up.

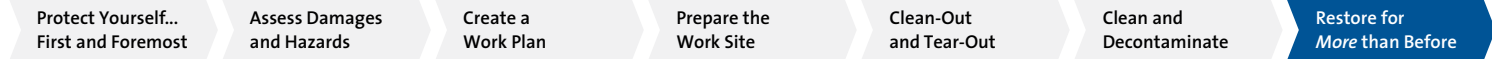

## Damage-resistant materials

- ▶ Restore with flood-resistant replacement materials, which also tend to be less vulnerable to mold. FEMA evaluates and publishes detailed information about flood-resistant materials (see [www.fema.gov](http://www.fema.gov)). Examples include:
  - **Floorings:** Porcelain or glazed ceramic tile, solid vinyl tile or inlaid sheet vinyl with no paper backing; waterproof adhesives and mortars; decorative concrete, terrazzo, stone, brick, solid hardwood planks (not coated with polyurethane or other impermeable finish); exterior grade plywood subflooring.
  - **Interior walls:** Paperless (fiberglass mat-faced) gypsum drywall with a moisture resistant core; removable wainscoting made of solid wood, plywood or fiber-cement panels; removable or composite trim. (Note: Finish with latex paint and never use vinyl wallpaper since it can trap moisture in walls and lead to hidden mold.)
  - **Exterior cladding:** Brick veneer; fiber-cement, vinyl, aluminum, or high-tech moisture-resistant composite sidings and trim with long warranties.
  - **Openings:** Metal or fiberglass-skin doors with closed cell insulation cores and composite framing; metal, fiberglass or vinyl frame windows.
  - **Elevate** appliances, equipment, wiring and outlets above the potential flood level. Place water heaters and A/C compressors on sturdy platforms. Wall ovens and front-loading laundry equipment placed on a platform or drawer unit could protect them from shallow floods.

## Foundations

- ▶ Hire a qualified professional to evaluate, repair and reinforce basement and foundation walls to withstand the pressures of flooding. Cracked or settled foundations may require anchors, shoring, or underpinning. There is a variety of techniques, so seek an engineered system and an installation firm with a solid track record of success. Best are systems that are well connected to the building, have lateral bracing, and ideally some flex and adjustability.
  - In flood hazard zones, flood vents are required by the National Flood Insurance Program in foundation walls within one foot of the ground to prevent failure from the pressure of rising floodwater.
  - Paint the exterior of above-ground foundation walls and slabs with latex paint to resist liquid water absorption, but allow water vapor diffusion to help them dry. If possible, upgrade waterproofing of exterior of basement walls to withstand high water pressure.
  - Use only flood-resistant materials inside a basement or crawlspace. Insulate with closed cell foam insulation. Relocate equipment out of the basement or above flood risk.

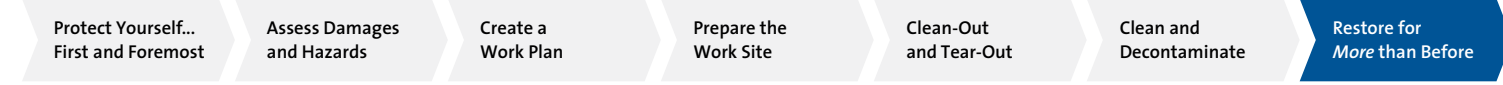
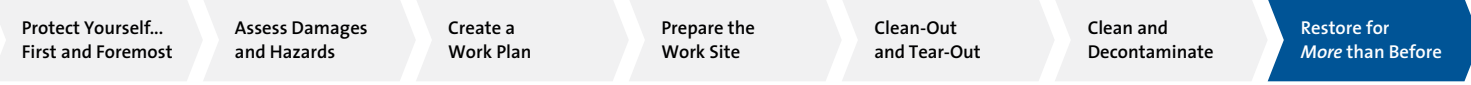

- When possible, the best solution is to elevate the entire house above flood risk. Homeowner flood insurance policies and some communities that receive disaster mitigation grants provide financial resources to elevate homes that have flooded. Check with your county government’s floodplain or emergency management office and your flood insurance policy.

**Walls**

- ▶ If walls are open or you will rebuild, consider creating a “drainable, dryable wall” assembly:
  - Partially fill wall cavities with closed cell spray foam insulation (2 lb. density) or rigid foam board cut to fit; or, insulate with exterior foam sheathing and leave the wall cavity empty. Closed cell foam insulation doesn’t absorb water. Leaving some empty space in the wall fosters drainage and drying.
  - Install paperless drywall with gaps or gaskets between panels to block wicking across panels. Also leave gaps at the top and bottom, covered by moldings that can be removed after a flood to allow the wall cavities to be rinsed, drained and ventilated for drying.
  - Use flood-resistant exterior materials, such as plywood sheathing, closed cell rigid foam sheathing, synthetic housewrap (weather barrier), and fiber cement siding or brick veneer. Be sure there is a drainage gap behind the cladding.

**Wind- and hail-resistant improvements – for a stronger, safer home and less water damage.**

Today, many wind- and impact-rated products and effective weather barrier systems (water excluding) are widely available. It’s a good investment to upgrade when replacing damaged materials.

**Roof**

If reroofing, remove all of the existing roof covering and specify a high-wind and hail-rated roof system. It must be installed according to manufacturer instructions to perform as rated and be covered by the warranty. For more detailed information, see [www.disastersafety.org](http://www.disastersafety.org).

1. If replacing roof decking, upgrade to F/1” plywood.
2. Reinforce existing and new roof decking with **ring shank nails** (0.113-inch diameter, 2-D/1-inch long or longer with full round head) spaced every 6 inches.



**PHOTO:** Ring shank nails provide greater pull-out resistance in high wind.

**• • • RECOMMENDED ROOF COVERING STANDARDS • • •**

Shingles should meet standards based on the wind speed for which protection is desired. Test standards are typically listed on the packaging shingles come in.

WIND SPEED	ASTM D3161	ASTM D7158
60 mph	Class A	—
90 mph	Class D	Class D
110 mph	Class F	
120 mph	—	Class G
150 mph	—	Class H

**Recommended Product Testing Standards**

- ▶ Class A, D or F wind resistance – ASTM D3161
- ▶ Class D, G, or H wind resistance – ASTM D7158 (preferred)
- ▶ Class A fire resistance – UL 790 or ASTM E108
- ▶ Class 3 or 4 impact resistance (class 4 is better) – UL 2218 or FM 4473

For standards and more information, go to [www.astm.org](http://www.astm.org), [www.ul.com](http://www.ul.com), or [www.fmglobal.com](http://www.fmglobal.com)

3. Add a **secondary moisture barrier** to prevent leaks at seams if roofing is lost to high wind. This can be created by taping the decking seams with a roofing tape (do not use window flashing tape). Also use wide adhesive membrane shields in roof valleys and along eaves.
4. Upgrade the underlayment. Use at least #30 roofing felt. Better options are a tear-resistant **synthetic** underlayment, or an adhesive membrane (peel and stick) underlayment for greatest protection (no need for taped seams if this is used).
5. Install **Class H** (150 mph wind tested) and **UL Class 4** impact-rated roofing systems for highest storm resistance. Shingles rated for high wind usually require matched starter strips and 6 nails per tab to perform as tested and be warranted. Wind- and impact-resistant asphalt shingle, metal, slate and tile systems are now available.
6. Securely fasten strong soffits under overhangs, such as plywood or fiber cement panels.



**PHOTO:** A water-resistant barrier layered over step flashing at a roof-to-wall intersection.





### Structure

If walls are open or siding is removable, add metal straps and clips to strengthen connections of wall framing to the foundation, to the roof rafters or trusses, and between levels. Also strengthen accessory structures (screen porches, tool sheds, etc.) that could become flying debris. Remove trees and limbs near the house that pose a risk of breaking or uprooting.

### Windows

If in a high wind zone, consider installing wind-borne debris protections such as impact-rated shutters, removable panels or impact-rated window and door systems.

### Weather Barriers

When replacing windows, doors, siding or any wall penetration, upgrade the weather resistive barrier and flashing system. Make sure **everything** is layered shingle-fashion with no gaps or tears. Use high performance caulks and sealants to reduce wind-driven water leaks.

### Safe Rooms

If you live in a tornado risk zone, consider investing in the addition of a tornado safe room that meets FEMA standards to provide secure shelter during even the strongest tornadoes. Pre-fabricated safe rooms are commercially available or can be built according to FEMA guidelines at: [www.fema.gov/safe-rooms](http://www.fema.gov/safe-rooms).

### Earthquake resistant improvements – to keep it together.

When building or repairing damage, make sure the foundation and structural plans, materials and connectors comply with local seismic building codes. Have a licensed engineer or architect evaluate and design repairs and reinforcements of the foundation, structure and connections that hold them together. Unreinforced masonry walls are especially vulnerable.

Additional measures you should take when restoring or renovating your home include:

- ▶ Install flexible connections and piping for gas and water lines.
- ▶ Brace water heaters with strapping and secure all equipment, cabinets and bookcases with screws that extend two inches into framing.
- ▶ Place large, heavy and breakable objects on the floor or lowest shelves. Provide storage for hazardous chemicals in lower cabinets with child safety locks. If you live in a flood zone, store these items above flood-risk level in anchored and locked cabinets.



**PHOTO:** Steel structural support added for earthquake resistance.

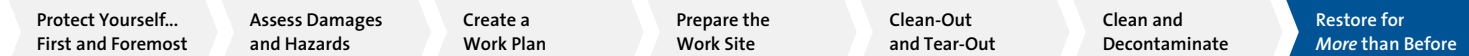

- ▶ Replace an upper chimney flue with a metal flue. Add plywood panels at the roof or ceiling joists to prevent chimney bricks from falling into the home.

### Wildfire protections – to resist wind-blown embers.

Wind-blown embers, which can travel a mile or more, are the biggest threat to homes near wildfire. Retrofits that can greatly increase protection from embers include:

- ▶ Remove dead vegetation on the roof, in gutters, and close to the home. Install gutter guards to keep debris out. Avoid combustible mulch; consider rock mulch instead.
- ▶ Reroof with a Class A (fire-resistant) roofing material or roof system. Close any gaps under roofing, install bird stops in barrel tile roofs.
- ▶ Enclose the underside of open eaves (soffits) and cover soffit vents and crawl space vents with B/1 to W-inch metal mesh screen to block embers. Keep the screen clean to maintain attic ventilation.
- ▶ Install a spark arrestor that has V-inch mesh on chimneys.
- ▶ If replacing windows, choose double or triple pane units with at least one pane of tempered glass.
- ▶ Use fire-resistant materials for siding, decks and fencing, install a non-combustible buffer between wood decks or fencing and the home.

### Freeze/snow-tolerant upgrades – to prevent trouble spots and keep warm and dry.

Roof damage from heavy snow load requires evaluation and reinforcement by qualified professionals, such as an architect, engineer or construction expert. There are simple solutions to prevent the more common burst pipes and roof leaks from ice dams:

- ▶ Install foam insulation sleeves on all water pipes, even those in heated spaces in case you lose heat. In deep freeze risk areas, install UL-approved heat tape on outdoor exposed pipes.
- ▶ Install pressure release valves in the plumbing system.
- ▶ Prevent ice dams on roof overhangs with airtight, well-insulated ceilings and good attic ventilation. These features keep the heat in your home from warming the attic and melting the bottom of snow on the roof. A well-sealed and insulated ceiling also improves energy efficiency and helps your home, and you, stay warm.
- ▶ When reroofing, install adhesive membrane on roof overhangs before installing roofing underlayment. Upgrade to synthetic underlayment or adhesive membrane for the entire roof.
- ▶ Plan for a safe back-up heat source in the event of an emergency. If it's a wood stove or fireplace, make sure it exhausts to the outdoors and has a duct to provide outside air for combustion.
- ▶ Direct-vent, sealed-combustion units are the safest option in gas appliances. They eliminate risk of backdrafting combustion pollutants and do not use indoor air to support the fire. This reduces cold drafts to help your home stay warm longer.

## Heat/drought management strategies – for structure and family survival.

### Foundations

Preventing foundation failure when parched soil shrinks can save both your foundation and entire home from major structural damage.

- ▶ To repair and prevent future foundation failures, simply “jacking it up” isn’t enough. Compare and use an engineered shoring system and an installation firm with a good track record.
- ▶ Install a drip irrigation system encircling and a few feet from the foundation to keep the soil moist during droughts. Spread mulch to slow moisture evaporation and irrigate around trees near the home so their thirsty roots don’t cause uneven soil moisture levels.

**Sun control strategies** in home design and materials can help you tolerate extreme heat when you have no air conditioning or power:

- ▶ Shade windows with drought-tolerant landscaping, large roof overhangs, awnings, Bahamas shutters or solar screening, or apply heat-blocking solar film to single-pane windows. Overhangs on south facing windows can provide summer shade yet admit winter sun.
- ▶ If replacing windows, choose low-e windows with a low solar heat gain coefficient (SHGC < 0.30) where there is not full shade in summer. Choose casement windows to funnel breezes and double-hung windows for cross ventilation.
- ▶ Surround your home with vegetation and avoid unshaded pavement around the home.
- ▶ Select white or light colored exterior finishes and materials.
- ▶ Consider a solar reflective *cool roof* (labeled Energy Star), especially if installing metal roofing.

Heat also takes a toll on the longevity of most building materials. Choose more durable, longer warranty and UV-resistant exterior materials with light colors to reflect heat, especially in warm climates.

### Tsunami/storm surge rebuilding – for safer coastal homes.

Strive to meet current coastal construction standards for velocity wave zones. Coastal construction guidelines are available at [www.fema.gov](http://www.fema.gov). Make sure that the home plans specify that:

- ▶ The lowest part of the subfloor is above possible wave heights
- ▶ Foundation pilings are deep enough to withstand scouring out of soil by strong currents
- ▶ No walls, structures other than stairs, or items are kept under the house (breakaway walls may be allowable by code, but become debris that can damage other buildings or people).

### Sinkholes/mudslides/falling debris and any catastrophe – tough decision time.

Destruction of a home by any type of disaster brings the tough choice of whether to relocate to a lower-risk area or rebuild in the same risk area. Relocation is often the best decision. There can be several resources to help and reduce financial losses. Check with your local disaster assistance center (temporary for major disasters) or emergency preparedness office.

## HEALTHY HOME IMPROVEMENTS

Restoring a damaged home is also an opportunity to make your home an even better place to breathe, live, thrive and enjoy than ever before – when you apply healthy home principles in improvements. Review and, when possible, plan to include the following for a *healthy home*:



### Keep it Dry

With each and every renovation component, plan for water and moisture control.

- ▶ Specify leak prevention and moisture control weather barriers, integrated shingle-fashion, with full-protection flashing of windows, doors, and penetrations in renovations.
- ▶ Invest in a high-performance roofing system with upgraded underlayment for high resistance to leaks, wind and hail. Specify *step flashing* where roofs meet walls. (Read and enforce manufacturer installation recommendations.)
- ▶ Slope the grade and pavement within 10 feet of the house to provide good drainage of rainwater away from the foundation. A 5% or greater slope is recommended.
- ▶ Ensure indoor humidity control with bath, kitchen and laundry exhaust fans properly ducted to the outdoors, correctly sized air conditioners, and moisture barriers in the foundation system.
- ▶ Learn more about moisture and mold control methods for your climate zone. Explore the EPA mold site [www.epa.gov/mold](http://www.epa.gov/mold), the Department of Energy Building America Program Solution Center [bas.c.pnnl.gov](http://bas.c.pnnl.gov), HUD Healthy Homes [www.hud.gov/healthyhomes](http://www.hud.gov/healthyhomes), and the Cooperative Extension Service eXtension [www.extension.org](http://www.extension.org).



### Keep it Clean

Restore with easy-care, durable finishes and furnishings with smooth surfaces that can be wiped clean. Consider adding large commercial doormats, shoe cubbies and storage at the family entrance.



### Keep it Pest Free

Apply integrated pest management practices during home repairs by eliminating sources of food, water and shelter for pests. Seal gaps with pest-resistant barriers; eliminate places that can harbor pests; use



**PHOTO:** Use large commercial doormats to help keep soil-based contaminants (such as lead dust) out of your home.

borate-treated materials; install termite barriers and inspection access. Learn more from your local Cooperative Extension Service or [www.extension.org](http://www.extension.org) (search Household IPM).

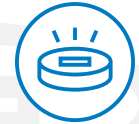

### Keep it Safe

Make your restored home a safer, convenient place for all ages and stages of life.

- ▶ Strengthen handrails, remove tripping hazards, and improve lighting.
- ▶ Add child-safe features, especially to avoid burns, falling out of windows, and poisoning.
- ▶ Install new smoke detectors, carbon monoxide (CO) alarms, fire extinguishers and GFCI (ground fault circuit interrupter) outlets in wet areas.
- ▶ Include adaptable and accessible (universal design) features like 3-foot wide doorways with low thresholds; bath grab bars; sinks and appliances that can be reached while seated; lower counters with knee space; lever handles; curbless showers, etc.



**PHOTO:** GFCI outlets are safer than other types of outlets in wet areas.



### Keep it Contaminant-Free

In addition to controlling mold, lead, asbestos, chemicals and bio-hazards during clean-up, include these improvements in your restoration.

- ▶ Avoid risk of combustion pollutants with direct-vent, sealed-combustion furnaces, water heaters and fireplaces that cannot backdraft into the home. Install quiet exhaust hoods over gas cooktops (so they will be used).
- ▶ Rigorously air seal between the garage and living space, or separate the garage from the home.
- ▶ Use low VOC (volatile organic compound) paints, adhesives and finishes; choose low-formaldehyde insulation and wood products; choose Green Label, low-emission carpets, air out new carpets for three days, and air out new foam mattresses until no odor is detected.
- ▶ Plan storage space for household chemicals outside the living space and above likely flood level.



### Keep it Properly Ventilated

Improve exhaust and fresh air ventilation, filtering and distribution to dilute indoor air pollutants.

- ▶ Install spot exhaust fans in all bathrooms and over the cooktop with properly installed ducting to the outdoors (not into the attic). Exhaust clothes dryers to the outdoors with short metal ducts.
- ▶ Replace damaged fuel-burning heaters with direct-vent, sealed-combustion types or electric heat pumps to eliminate risk of backdrafting.
- ▶ Seal heating and cooling ductwork and air returns airtight with *mastic*, not duct tape.

- ▶ Choose smooth floorings when occupants have dust mite allergies or asthma.
- ▶ Install a **radon mitigation system** if you live in a medium or high radon risk zone (see [www.epa.gov/radon/zonemap.html](http://www.epa.gov/radon/zonemap.html)). Radon is a cancer-causing radioactive soil gas that can build up in homes. Nearly one out of 15 homes in the U.S. has elevated radon levels – above EPA’s action limit of 4 picocuries of radon per liter of air (4 pCi/L).

Most radon enters homes through the basement or foundation. It seeps in through cracks, construction joints, cracks in walls, gaps in suspended floors, gaps around service pipes, cavities inside walls, and the water supply.

EPA recommends these methods to help add radon-resistance to homes during rebuilding after a disaster. See [www.epa.gov/radon](http://www.epa.gov/radon) for more information and to find qualified radon contractors.

- When replacing, elevating or adding a new house foundation (concrete slab), use a 4-inch layer of clean, coarse gravel below it to allow the radon to move freely underneath the house. Place heavy duty plastic sheeting (6 mil. polyethylene) as a vapor retarder on top of the gravel. The sheeting prevents soil gases from entering the house and keeps concrete from clogging the gravel layer when the slab is poured.
- Run a 3- to 4-inch solid PVC Schedule 40 pipe labeled “Radon System” vertically from the gravel layer below the slab, through the house’s conditioned space, and through and above the roof to safely vent radon outside and above the house.
- Seal all openings, cracks, and crevices in the concrete foundation floor (including the slab perimeter crack) and walls with polyurethane caulk to prevent radon from entering the home.
- Install an electrical outlet in the attic for use with a vent fan for the radon exhaust pipe, as needed now or in the future.

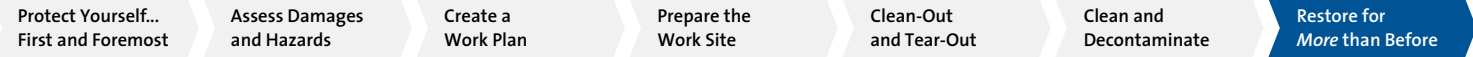

- ▶ Use air filters rated MERV 8 to 10 or higher. Note that high efficiency filters may restrict air flow too much for some systems. Check with your system manufacturer or HVAC contractor.
- ▶ Consider adding a balanced fresh air supply system and improved air distribution.



### Keep it Maintained

Make your restored home a low-maintenance home.

- ▶ Choose long-warranty, low-maintenance replacement siding, roofing, windows, doors and steps.
- ▶ Install leaf guards on gutters. Or, if you rebuild the roof, create 2-foot or larger roof overhangs without gutters and moderate roof slopes to shed water away from the house.
- ▶ Reroof with wind- and hail-rated roofing, even if you're not in a hurricane or tornado zone. Wind and hailstorms can occur anywhere.



### Keep it Comfortable

Make it easier and more affordable to stay warm in winter and cool in summer with energy-efficiency improvements. See [www.energystar.gov](http://www.energystar.gov), [basc.pnnl.gov](http://basc.pnnl.gov) and [www.extension.org](http://www.extension.org) to learn how to weatherize without causing moisture or health problems.



- ▶ Restore gutted walls, ceilings and floors with higher-R value insulation installed with no gaps, voids or compression.
- ▶ Air seal the entire enclosure of your living space, especially at the ceiling, to stop air leaks. Uncontrolled air leaks can cause discomfort, higher energy costs, moisture problems, and sometimes draw in pollutants from attics or crawl space.
- ▶ If you have central air conditioning and/or heat, get your ductwork leak tested and sealed as airtight as possible.
- ▶ Replace any damaged or worn out HVAC, windows, doors, appliances, electronics and lighting with models having Energy Star labels. Compare the yellow Energy Guide labels on appliances before buying.
- ▶ Include sun control strategies to cut summer heat gain, such as landscaping, solar film or screens, awnings, and light exterior colors. In warm climate zones, install a radiant barrier under the roof of a vented attic with the shiny side down, or replace roof decking with foil-lined decking.

## Appendix 1 – Supplies and Materials

To help you plan and prepare efficiently, following is a general list of supplies and materials you might need. Add other items you will need to this list.

### CLEAN-UP, HEALTH AND SAFETY STATION SUPPLIES

- List of emergency phone numbers
- Well-stocked first aid kit
- Eye wash station
- 3 to 5 clean-up buckets
- Pump sprayer (for clean water)
- Hand soap, detergent, hand sanitizer
- Scrub brushes
- Paper towels, tissues
- Trash bin or bags
- Table (weather resistant)
- Rack for hanging work clothes, respirators
- Bottled water

### PERSONAL PROTECTIVE EQUIPMENT (PPE)

- Lungs:** N100 respirators (min. N95 if home built after 1980)
- Eyes:** Goggles or safety glasses
- Ears:** Ear plugs or earmuffs
- Feet:** Non-skid shoe covers, work boots, rubber boots
- Head:** Cap with brim or hard hat
- Hands:** Waterproof, cut-resistant gloves; chemical resistant gloves
- Body:** Disposable coveralls with elastic wrists and ankles or removable work clothes
- Other safety gear:** Tethers, back support belt, etc. as needed

### TOOLS AND EQUIPMENT

- Fire extinguishers (10ABC type)
- Work lights (break-resistant), portable lanterns, flashlights
- Generator (gasoline or solar kit), gas cans (if needed)
- Extension cords (three-wire heavy duty, outdoor)
- Wet/dry shop vacuum cleaner
- HEPA vacuum cleaner, spare filter bags and filters
- Dehumidifier, drain hose
- Fans (box fan for containment negative pressure; fans for comfort)
- Ladders
- Shovels
- Chain saw
- Wheelbarrow, handcart, high-capacity dolly
- Pliers with end-cut
- Crowbar
- Wrench
- Hammers and assorted nails
- Staple gun, staples
- Saws: reciprocating, drywall, circular, handsaw
- Power tools (drill, saw, screwdriver)
- Current tester (for electrical work)
- Moisture meter
- Pocket knife
- Carpet cutter
- Measuring tape, retractable
- Straight edge
- Pump sprayer
- Hand sanders and planers, paint scrapers
- Tool box, tool pouch or belt
- Other needs: \_\_\_\_\_

## SUPPLIES

- Cell phone and charger, solar charger
- Batteries (for lights, meters, testers)
- Camera
- Reading glasses
- Cooler for food and drinks
- Door mats
- Water hose, water jugs
- Mops, brooms and dust pans
- Scoops, disposable containers
- Abrasive sponges, soft sponges, rags, scrub brushes, stiff brush
- Buckets
- All-purpose cleaner – low suds, phosphate free
- Disinfectant solutions (appropriate to surface)
- Spray mister (hand-held), wet/dry abrasive paper, wet sanding sponges (for wet-methods)
- Heavy duty, contractor trash bags
- Bungee cords, rope
- Plastic sheeting, 6 mil roll
- Roof tarp, roofing nails, roofing cement
- Weather barrier materials (housewrap, cap nails, etc.)
- Masking tape, duct tape
- Construction adhesive, epoxy, caulks
- Pieces of lumber: 2 × 4's, furring strips
- Plywood
- Lead dust test kits (EPA-recognized, see [www.epa.gov/lead](http://www.epa.gov/lead))
- Fungicide, mildewstat coatings (water vapor permeable, only)
- Borate treatment solution
- Plaster repair, drywall spackle, joint compounds
- Gypsum drywall, paperless, water-resistant drywall
- Latex paints, primers, finishes (water vapor permeable)
- Weather stripping, foam sealant, etc.
- Replacement insulations, sheathing, etc.
- Hurricane hardware, ring shank nails
- Other needs: \_\_\_\_\_  
\_\_\_\_\_  
\_\_\_\_\_

## Appendix 2 – Glossary

### DESCRIPTIVE DEFINITIONS

- ▶ **black water** – Contains disease-causing (pathogenic) agents and is extremely unsanitary; includes sewage and flooding from seawater, rivers or other rising stormwater.
- ▶ **borate solution** – Treatment containing borate salts, derived from the natural element boron, used to protect wood from termites, other wood destroying insects, algae and decay fungi.
- ▶ **bottom plate/sill plate/sole plate** – A horizontal framing member at the bottom of a wall, on which the vertical studs or framing panel of the wall rest.
- ▶ **cladding** – The exterior finish material of a building, such as roofing, siding, brick, stucco, etc.
- ▶ **closed cell foam** – A type of rigid panel or spray-on foam insulation with a solid cell structure and medium to high density (2-3 lb./cubic foot); properties include high insulating R-value (R 5-8/inch), low water vapor permeability, non-absorbent, low water wicking, and rigidity that can structurally reinforce a building assembly; spray-applied foam can create an airtight seal.
- ▶ **combustion equipment** – Appliances that burn fuel for energy, including gas furnaces, space heaters, water heaters, ranges, and clothes dryers; oil-fired boilers; fireplaces, wood stoves, etc.
- ▶ **containment** – Isolating a space to keep something harmful under control or within limits; typically involves sealing off air vents and openings to clean rooms with plastic sheeting and tape, and drawing air from the work area to outdoors (negative pressure).
- ▶ **fibrous insulation** – Insulation product made with fiberglass, mineral wool, cellulose, cotton or other material with small fibers; the air space between fibers resists conduction of heat through the material (R-value varies), but can hold water, so the material should be replaced when wet.
- ▶ **firebrands** – Burning material that is lifted in air currents, transporting fire to other areas; also called *ember showers*.
- ▶ **flashing** – A waterproof material designed to redirect, block or shed water; process of installing materials that prevent water intrusion at roof and wall penetrations, windows, doors, etc.
- ▶ **flood vent** – An opening in an enclosed foundation wall or structure to allow the free flow of water in and out, in order to prevent structural damage from the floodwater pressure; generally required for homes in flood hazard zones.
- ▶ **footing** – The part of a foundation bearing directly upon the earth, usually underground.
- ▶ **GFCI** (ground-fault circuit interrupter) – A fast-acting circuit breaker designed to shut off electric power and prevent electric shock in the event of a break in the grounding path from a tool or electric circuit to the earth.
- ▶ **gray water** – Unsanitary water not suitable for drinking, but unlikely to contain disease-causing contaminants; includes waste water or leaks from sinks, tubs, dishwashers, washing machines and waterbeds.

- ▶ **HEPA** (high efficiency particulate air) – A filter designed to capture 99.97% of airborne particles measuring 0.3 micrometers or greater in diameter passing through it.
- ▶ **housewrap** – Common term for a weather barrier sheet material installed over exterior wall sheathing and under cladding to shed water, protecting framing and insulation from water damage; may also be sealed to limit air leakage, yet allow water vapor to escape (vapor permeable).
- ▶ **HVAC** – Heating, ventilation, and air conditioning system, including any ductwork.
- ▶ **joists** – The parallel wood or metal framing members that span from wall to wall in a structure to support a floor or ceiling.
- ▶ **lath** – Thin, flat strips of wood or wire mesh, used as backing for plaster or stucco on a wall or tiles on a roof.
- ▶ **mastic** – A compound that remains adhesive and pliable with age; recommended to create a durable, airtight, waterproof seal in air ductwork.
- ▶ **MERV** (minimum efficiency reporting value) – A standardized rating of the effectiveness of an air filter at removing particles from the air that passes through it, ranging from a low of 1 to a high of 20; higher MERV filters remove smaller particles; filters rated MERV 7–13 may be nearly as effective as HEPA filters at capturing airborne indoor particles.
- ▶ **meter (gas, electric or water)** – A specialized flow meter that measures the volume (of gas, electricity or water) used; typically installed outside of a home; gas and water meters usually have a shutoff valve.

- ▶ **mycotoxin** (pronounced “my kuh tock sin”) – A poisonous substance produced by a fungus, including some types of mold.
- ▶ **negative air pressure** – A containment safety practice where work area air is exhausted outside to prevent contaminated air from traveling to clean areas of the home.
- ▶ **open cell foam** – A low-density spray foam insulation (0.5 lb./cubic foot) in which the cells are not completely closed; properties include ability to create an airtight seal, R 3.5 to 3.7 insulating value, vapor permeable, can absorb water, remains soft and more flexible than rigid foam.
- ▶ **OSB** (oriented strand board) – An engineered wood structural panel made of wood strands and flakes bonded together with resins under heat and pressure; typically used as wall or roof sheathing and subflooring.
- ▶ **particleboard** – An engineered wood product made from wood chips, sawmill shavings or sawdust and a binder, that is pressed and extruded into panels; made in a range of densities and strengths; most types prone to expansion and weakening from moisture; used in indoor furniture and cabinets.
- ▶ **PPE** (personal protective equipment) – Specialized clothing and equipment worn for protection against health and safety hazards; includes respirators, goggles, gloves, etc.
- ▶ **pressboard/pressed wood** – A dense composite material, typically made from layers of recycled paper, textile or wood pulp formed into boards or sheets with

- adhesive and heat; usually covered with a laminate or skin when used in furniture, cabinets and counters; most types prone to expansion and weakening from moisture.
- ▶ **radiant barrier** – A shiny material, such as aluminum foil, placed in an airspace to block radiant heat transfer between a heat-radiating surface (such as a hot roof) and a heat-absorbing surface (such as air ductwork and ceilings); typically used in homes in warm climates to reduce heat gain.
- ▶ **radon** – A cancer-causing, invisible, radioactive soil gas that can seep into and build up in homes; the second leading cause of lung cancer.
- ▶ **rafters** – The sloping boards or beams of roof framing that extend from the peak of a roof to the eaves.
- ▶ **reciprocating saw** – A portable power saw in which the cutting action is achieved through a push and pull motion of the blade.
- ▶ **relative humidity (RH)** – The ratio (%) of the amount of water vapor in air compared to how much moisture air could hold at the same temperature; RH 40% to 60% is preferred range for comfort and health; lower RH speeds drying of wet materials.
- ▶ **rim board/rim joist/band joist** – A structural board or band around the perimeter of floor framing (on the foundation or between levels), to which the ends of joists are attached.
- ▶ **scour** – A localized loss of soil, often around a foundation element, caused by floodwater flowing around it.

- ▶ **sill** – The lowest horizontal framing member resting on the foundation and supporting floor joists or studs; also a term for the lowest part of a window or exterior door frame.
- ▶ **sheathing** – A layer of boards, plywood, OSB or other panel material applied to studs, joists or roof rafters to strengthen the structure and provide a base for attaching cladding.
- ▶ **shoring** – A general term for the process of adding support to a structure or foundation to prevent collapse or failure, such as to remedy uneven settling of a foundation; foundation shoring may involve underpinning.
- ▶ **soffit** – The underside of a protruding part of a building, such as a roof overhang.
- ▶ **spark arrestor** – A device that prevents the emission of flammable debris from combustion sources such as a fireplace or wood burning stove.
- ▶ **step flashing** – Short pieces of flashing applied along an exterior wall or chimney where it intersects a roof surface; each piece is installed to overlap the shingle in the course below, and to be overlapped by the shingle in the course above to channel rainwater over shingles and prevents leaks; method required by most shingle manufacturers.
- ▶ **truss** – A framework of individual structural members arranged (usually in triangles) and connected together to form a strong support unit that can span a distance, such as an engineered roof truss or floor joist truss.

- ▶ **underlayment (roof)** – A water-resistant felt or other sheet material (may be a self-adhering membrane) installed between the roof decking and roof covering, usually used in sloped roof construction.
- ▶ **underpinning** – The process of modifying an existing foundation system by extending it to deeper, more stable soil than the soil level that previously supported foundation; may be called *foundation shoring*.
- ▶ **unreinforced masonry** – Brick, cinderblock, tiles, adobe or other masonry material that is not braced by reinforcing beams or steel rebar, thus vulnerable to earthquake damage.
- ▶ **vapor permeable** – Allows gases (such as water vapor) to pass through it; the higher a *perm rating* of a material, the more vapor permeable it is.
- ▶ **VOC** (volatile organic compound) – Chemicals that can evaporate into the air from a liquid or solid product at normal temperatures and conditions; high VOC household and construction products can be a source of unhealthy indoor air pollutants.
- ▶ **wicking water line** – A visible marking that reflects the level of wetting that occurred beyond a flood level, due to moisture wicking through a material (capillary action); after a flood, the wicking line on drywall is often more than a foot above the flood level.

### ACRONYMS AND ABBREVIATIONS

- CDC** – Centers for Disease Control and Prevention
- CO** – carbon monoxide
- EPA** – Environmental Protection Agency
- FEMA** – Federal Emergency Management Agency
- GFCI** – ground-fault circuit interrupter
- HEPA** – high efficiency particulate air
- HUD** – United States Department of Housing and Urban Development
- HVAC** – heating, ventilating and air conditioning
- IPM** – integrated pest management
- IRC** – International Residential Code
- MERV** – minimum efficiency reporting value
- NFIP** – National Flood Insurance Program
- NIOSH** – National Institute for Occupational Safety and Health
- NVLAP** – National Voluntary Laboratory Accreditation Program
- OSB** – oriented strand board
- OSHA** – Occupational Safety and Health Administration
- PPE** – personal protective equipment
- RH** – relative humidity
- UL** – Underwriters Laboratory
- VOC** – volatile organic compound

### Disclaimer

The website addresses in this document were verified shortly before publication, but some of them will change over time, and additional websites of interest will be created. If a particular page is no longer valid or is outdated, a higher-level page may be checked (e.g., starting a search at [www.abc.gov](http://www.abc.gov), when [www.abc.gov/def](http://www.abc.gov/def) is invalid or no longer useful), or a web search engine may be used to look for the term(s) of interest.

## Appendix 3 – For more information...

### DISASTER AND RESILIENT HOME RESOURCES

Find where and how to access disaster recovery help and resources.

- ▶ [www.DisasterAssistance.gov](http://www.DisasterAssistance.gov)  
(Disaster Assistance Improvement Program)

Learn about methods and certification programs to fortify your home against natural hazards.

- ▶ [www.DisasterSafety.org](http://www.DisasterSafety.org)  
(IBHS – Insurance Institute for Building & Home Safety)

Discover your flood risk and what to do about it.

- ▶ [www.FloodSmart.gov](http://www.FloodSmart.gov)  
(NFIP – National Flood Insurance Program)

See how to prepare your home and family for any natural hazard.

- ▶ [www.flash.org](http://www.flash.org)  
(FLASH – Federal Alliance for Safe Homes)

Learn about federal programs and resources for planning, preparing and recovering from disasters.

- ▶ [www.fema.gov](http://www.fema.gov)  
(FEMA – Federal Emergency Management Agency programs main)

### FINDING QUALIFIED CONTRACTORS AND PROFESSIONALS

Find certified home cleaning, restoration and remediation professionals.

- ▶ [www.acac.org](http://www.acac.org)  
(American Council for Accredited Certification)
- ▶ [www.certifiedcleaners.org](http://www.certifiedcleaners.org)  
(Institute of Inspection Cleaning and Restoration Certification)
- ▶ [www.restorationindustry.org](http://www.restorationindustry.org)  
(Restoration Industry Association)

Find qualified asbestos professionals and laboratories.

- ▶ [www.epa.gov/asbestos](http://www.epa.gov/asbestos)  
(EPA – Environmental Protection Agency asbestos website; use Hire an Asbestos Professional)
- ▶ [www.nist.gov](http://www.nist.gov)  
(National Institute of Standards and Technology website; select Laboratory Accreditation (NVLAP))

Get specifications for building a tornado safe room.

- ▶ [www.fema.gov/safe-rooms](http://www.fema.gov/safe-rooms)  
(FEMA safe room)

Access federal agency telecommunication services for people with speech and hearing disabilities.

- ▶ [www.gsa.gov/fedrelay](http://www.gsa.gov/fedrelay)  
(Federal Relay)

Learn about HUD disaster resources.

- ▶ [www.hud.gov](http://www.hud.gov)  
(HUD – U.S. Dept. of Housing and Urban Development; enter Disaster Recovery into the search box)

Explore protective measures to take before, during, and after an emergency.

- ▶ [www.ready.gov](http://www.ready.gov)  
(FEMA – Federal Emergency Management Agency website for households)

Find disaster shelters and recovery guidance.

- ▶ [www.RedCross.org](http://www.RedCross.org)  
(The American Red Cross)

Find certified Lead-Safe Renovators in your area.

- ▶ [www.epa.gov/lead](http://www.epa.gov/lead)  
(EPA – Environmental Protection Agency lead poison prevention)

Find home building and renovation contractors who belong to national professional organizations.

- ▶ [www.nahb.org](http://www.nahb.org)  
(National Association of Home Builders)
- ▶ [www.nari.org](http://www.nari.org)  
(National Association of the Remodeling Industry)

Find your state contractor licensing agency to verify contractors' licenses.

- ▶ [www.nascla.org](http://www.nascla.org)  
(National Association of State Contractors Licensing Agencies)

See worker safety guidelines and regulations.

- ▶ [www.osha.gov](http://www.osha.gov)  
(Occupational Safety & Health Administration)

### HEALTH HAZARDS (asbestos, mold, lead, radon, biohazards, etc.)

Search the index to learn more about home environment health hazards, diseases and helpful resources.

- ▶ [www.cdc.gov](http://www.cdc.gov)  
(Centers for Disease Control and Prevention)

Learn about asbestos hazards and safety.

- ▶ [www.epa.gov/asbestos](http://www.epa.gov/asbestos)  
(EPA – Environmental Protection Agency asbestos information)
- ▶ [www.nachi.org/asbestos](http://www.nachi.org/asbestos)  
(International Association of Certified Home Inspectors asbestos webpage)

Learn about lead poisoning hazards, effects and lead-safe work practices.

- ▶ [www.epa.gov/lead](http://www.epa.gov/lead)  
(EPA lead information)

Learn about mold hazards, prevention and remediation guidelines.

- ▶ [www.epa.gov/mold](http://www.epa.gov/mold)  
(EPA mold information)

Learn about the health hazards of radon, how to test your home, and radon mitigation systems.

- ▶ [www.epa.gov/radon](http://www.epa.gov/radon)  
(EPA radon information)

### HEALTHY HOME RESOURCES

Explore healthy home topics, programs and resources.

- ▶ [www.healthyhomes.hud.gov](http://www.healthyhomes.hud.gov)  
(The federal interagency healthy homes website)
- ▶ [www.cdc.gov/healthyhomes](http://www.cdc.gov/healthyhomes)  
(CDC healthy homes)
- ▶ [www.epa.gov/iaq](http://www.epa.gov/iaq)  
(EPA indoor air)
- ▶ [www.hud.gov/healthyhomes](http://www.hud.gov/healthyhomes)  
(HUD healthy homes)

Read the “Help Yourself to a Healthy Home” booklet and learn practical actions you can take.

- ▶ [www.hud.gov/offices/lead/library/hhi/HYHH\\_Booklet.pdf](http://www.hud.gov/offices/lead/library/hhi/HYHH_Booklet.pdf)

Explore healthy home research, policy issues, standards and publications.

- ▶ [www.lung.org/healthy-air](http://www.lung.org/healthy-air)  
(American Lung Association healthy air)
- ▶ [www.nchh.org](http://www.nchh.org)  
(The National Center for Healthy Housing)
- ▶ [www.osha.gov/SLTC/indoorairquality](http://www.osha.gov/SLTC/indoorairquality)  
(OSHA indoor air quality)

### OTHER HOME RESTORATION RESOURCES

Search building code provisions online or order codes and standards publications.

- ▶ [www.iccsafe.org](http://www.iccsafe.org)  
(International Code Council)

Learn ways to increase comfort, save money and have a more energy-efficient home with good indoor air quality.

- ▶ [www.energy.gov](http://www.energy.gov)  
(U.S. Department of Energy website; select Energy Saver)
- ▶ [www.energystar.gov](http://www.energystar.gov)  
(EPA Energy Star)
- ▶ <https://basc.pnnl.gov>  
(U.S. Department of Energy Building America Program Solution Center)

Explore the interactive online learning environment of America’s land-grant universities for research based information on disaster issues, home energy, moisture control and many other topics.

- ▶ [www.eXtension.org](http://www.eXtension.org)  
(Cooperative Extension Service information resource)

Learn how to prepare your home and family for disasters.

- ▶ [www.redcross.org/prepare/location/home-family](http://www.redcross.org/prepare/location/home-family)  
(The American Red Cross)

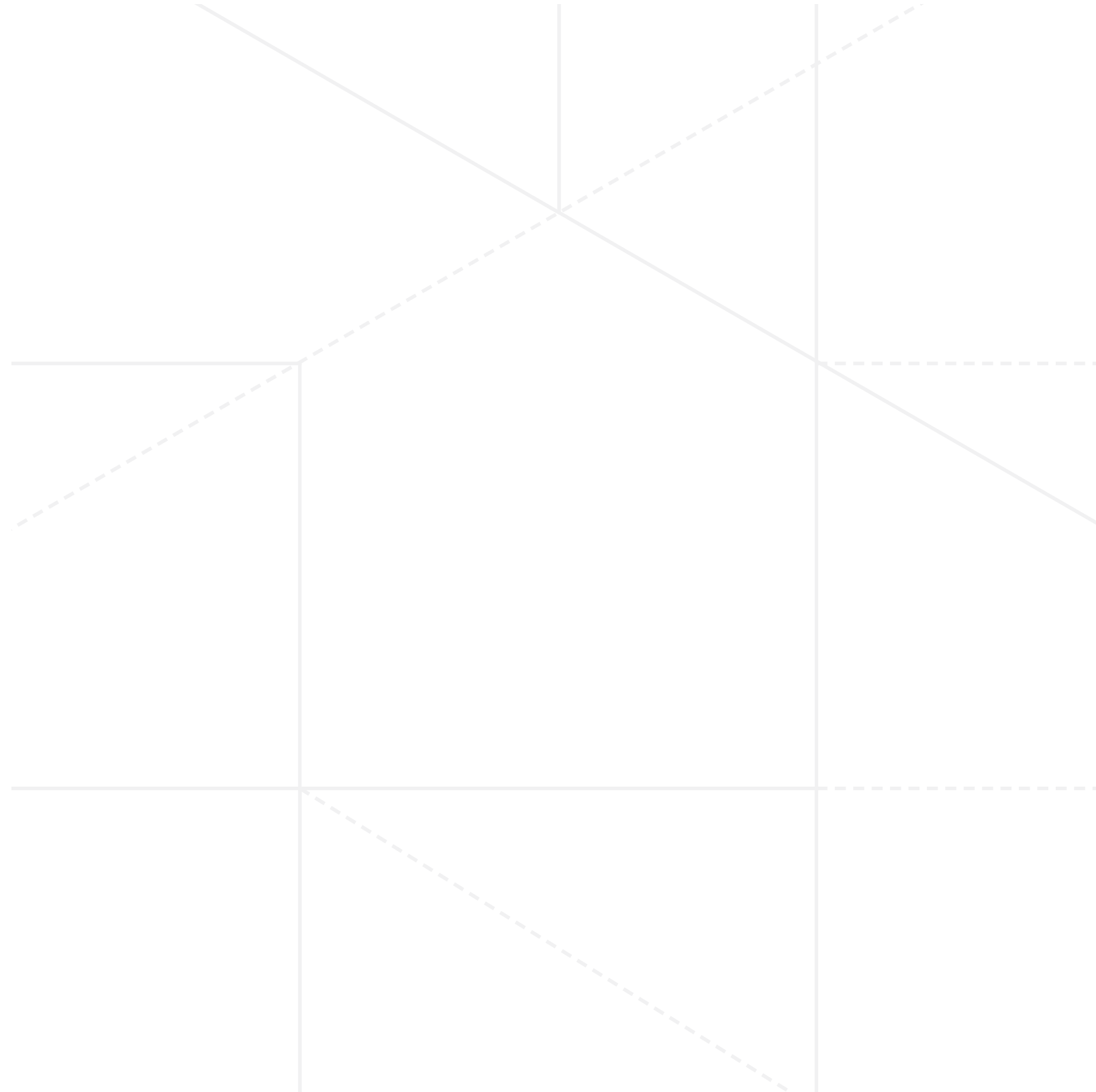



# Top 10 Tips

## for Rebuilding Healthy Homes

- 1** Remind yourself often to **put people before property!** Make safety your top priority ([page 10](#)).
- 2** **Wear personal protective equipment (PPE)**, including protective clothing and a NIOSH-approved respirator, **every** time you set foot in a damaged or moldy building ([pages 11 to 14](#)).
- 3** **Assess** structural stability and hidden hazards before you enter. A professional inspection may be needed ([pages 15 to 30](#)).
- 4** **Prepare a plan** (supplies and methods), **make a map** (disposal and clean-up site layout), and **review** insurance policies and disaster assistance resources ([pages 3](#) and [30 to 33](#)).
- 5** **Go slow** when pumping out water, then **act fast** to dry out and remove mold. Copy and share the *DIY Mold Removal Guidelines* sheet with workers ([pages 41](#) and [50 to 53](#)).
- 6** **Always remove wet insulation and foam padding**, even if the surface looks dry and clean ([pages 48 and 49](#)).
- 7** **Assume lead-based paint and asbestos** are in homes built before 1978 (unless verified not present). Be mindful that disturbing such materials increases the hazard ([pages 24 to 28](#)).
- 8** **Control dust, capture debris and contain contaminants** – with wet methods, drop cloths, debris bags, HEPA vacuums and workers trained in safe work practices ([pages 25 to 28, 39 and 40](#)).
- 9** **Check credentials** and hire only licensed and insured contractors, Lead-Safe Certified Renovators, certified Asbestos professionals, Mold Remediation Contractors, Fire and Water Damage Restorers, and other professionals, depending on types of work needed ([pages 33 to 35](#)).
- 10** **Restore for More than Before!** Install hazard-resistant materials, connectors and building systems. Include energy-saving and **healthy home improvements** ([pages 53 to 64](#)).

See [Appendix](#) for more sources of helpful information.



HEALTHYHOMES

